

CE



For sliding gates



Robus

500/500P

Instructions and warnings for the fitter

Istruzioni ed avvertenze per l'installatore

Instructions et recommandations pour l'installateur

Anweisungen und Hinweise für den Installateur

Instrucciones y advertencias para el instalador

Instrukcje i uwagi dla instalatora

Aanwijzingen en aanbevelingen voor de installateur

COMPANY
WITH QUALITY SYSTEM
CERTIFIED BY DNV
=ISO 9001/2000=

Nice

Robus

500/500P

Table of contents:

page

| | | | | | |
|------------|--|----|--------------|--|----|
| 1 | Warnings | 3 | 7.2.1 | Level one functions (ON-OFF functions) | 13 |
| 2 | Product description and applications | 4 | 7.2.2 | Level one programming (ON-OFF functions) | 14 |
| 2.1 | Operating limits | 4 | 7.2.3 | Level two functions (adjustable parameters) | 14 |
| 2.2 | Typical system | 6 | 7.2.4 | Level two programming (adjustable parameters) | 15 |
| 2.3 | List of cables | 6 | 7.2.5 | Level one programming example (ON-OFF functions) | 16 |
| 3 | Installation | 7 | 7.2.6 | Level two programming example (adjustable parameters) | 16 |
| 3.1 | Preliminary checks | 7 | 7.3 | Adding or removing devices | 16 |
| 3.2 | Installation of the gearmotor | 7 | 7.3.1 | BlueBUS | 16 |
| 3.3 | Fixing of the limit switch bracket on versions with inductive limit switch | 8 | 7.3.2 | STOP input | 17 |
| 3.4 | Installation of the various devices | 9 | 7.3.3 | Photocells | 17 |
| 3.5 | Electrical connections | 9 | 7.3.4 | FT210B Photo-sensor | 17 |
| 3.6 | Description of the electrical connections | 10 | 7.3.5 | ROBUS in "Slave" mode | 18 |
| 4 | Final checks and start up | 10 | 7.3.6 | Recognition of Other Devices | 19 |
| 4.1 | Choosing the direction | 10 | 7.4 | Special functions | 19 |
| 4.2 | Power supply connection | 10 | 7.4.1 | "Always open" Function | 19 |
| 4.3 | Recognition of the devices | 10 | 7.4.2 | "Move anyway" function | 19 |
| 4.4 | Recognizing the length of the leaf | 11 | 7.4.3 | Maintenance warning | 19 |
| 4.5 | Checking gate movements | 11 | 7.5 | Connection of Other Devices | 20 |
| 4.6 | Preset functions | 11 | 7.6 | Troubleshooting | 21 |
| 4.7 | Radio receiver | 11 | 7.6.1 | Malfunctions archive | 21 |
| 5 | Testing and commissioning | 11 | 7.7 | Diagnostics and signals | 21 |
| 5.1 | Testing | 12 | 7.7.1 | Flashing light signalling | 22 |
| 5.2 | Commissioning | 12 | 7.7.2 | Signals on the control unit | 22 |
| 6 | Maintenance and Disposal | 12 | 7.8 | Accessories | 23 |
| 6.1 | Maintenance | 12 | 8 | Technical characteristics | 24 |
| 6.2 | Disposal | 12 | | | |
| 7 | Additional information | 13 | | | |
| 7.1 | Programming keys | 13 | | | |
| 7.2 | Programming | 13 | | | |
| | | | | Instructions and Warnings for users of ROBUS gearmotor | 25 |

1) Warnings

This manual contains important information regarding safety. Before you start installing the components, it is important that you read all the information contained herein. Store this manual safely for future use.

Due to the dangers which may arise during both the installation and use of the ROBUS, installation must be carried out in full respect of the laws, provisions and rules currently in force in order to ensure maximum safety. This chapter provides details of general warnings. Other, more specific warnings are detailed in Chapters “3.1 Preliminary Checks” and “5 Testing and Commissioning”.

⚠ According to the most recent European legislation, the automation of doors or gates is governed by the provisions listed in Directive 98/37/CE (Machine Directive) and, more specifically, to provisions: EN 13241-1 (harmonised standard); EN 12445; EN 12453 and EN 12635, which enables to declare the conformity to the machine directive.

Please access “www.niceforyou.com” for further information, and guidelines for risk analysis and how to draw up the Technical Documentation. This manual has been especially written for use by qualified fitters. Except for the enclosed specification “Instructions and Warnings for Users of the ROBUS gearmotor” which is to be removed by the installer, none of the information provided in this manual can be considered as being of interest to end users!

- Any use or operation of ROAD200 which is not explicitly provided for in these instructions is not permitted. Improper use may cause damage and personal injury.
- Risk analysis must be carried out before starting installation, to include the list of essential safety requisites provided for in Enclosure I of the Machine Directive, indicating the relative solutions employed. Risk analysis is one of the documents included in the “Technical Documentation” for this automation.
- Check whether additional devices are needed to complete the automation with ROBUS based on the specific application requirements and dangers present. The following risks must be considered: impact, crushing, shearing, dragging, etc. as well as other general dangers.
- Do not modify any components unless such action is specified in this manual. Operations of this type are likely to lead to malfunctions. NICE disclaims any liability for damage resulting from modified products.
- During installation and use, ensure that solid objects or liquids do not penetrate inside the control unit or other open devices. If necessary, please contact the NICE customer service department; the use of ROBUS in these conditions can be dangerous.
- The automation system must not be used until it has been commissioned as described in chapter 5 “Testing and commissioning”.
- The ROBUS packing materials must be disposed of in compliance with local regulations.
- If a fault occurs that cannot be solved using the information provided in this manual, refer to the NICE customer service department.
- In the event that any automatic switches are tripped or fuses blown, you must identify the fault and eliminate it.
- Disconnect all the power supply circuits before accessing the terminals inside the ROBUS cover. If the disconnection device is not identifiable, post the following sign on it: “WARNING: MAINTENANCE WORK IN PROGRESS”.

Particular warnings concerning the suitable use of this product in relation to the 98/37CE “Machine Directive” (ex 89/392/EEC):

- This product comes onto the market as a “machine component” and is therefore manufactured to be integrated to a machine or assembled with other machines in order to create “a machine”, under the directive 98/37/EC, only in combination with other components and in the manner described in the present instructions manual. As specified in the directive 98/37CE the use of this product is not admitted until the manufacturer of the machine on which this product is mounted has identified and declared it as conforming to the directive 98/37/CE.

Particular warnings concerning the suitable use of this product in relation to the 73/23/EEC “Low Voltage” Directive and subsequent modification 93/68/EEC:

- This product responds to the provisions foreseen by the “Low Voltage” Directive if used in the configurations foreseen in this instructions manual and in combination with the articles present in the Nice S.p.a. product catalogue. If the product is not used in configurations or is used with other products that have not been foreseen, the requirements may not be guaranteed; the use of the product is prohibited in these situations until the correspondence with the requirements foreseen by the directive have been verified by installers.

Particular warnings concerning the suitable use of this product in relation to the 89/336/EEC “Electromagnetic Compatibility” Directive and subsequent modifications 92/31/EEC and 93/68/EEC:

- This product has been subjected to tests regarding the electromagnetic compatibility in the most critical of use conditions, in the configurations foreseen in this instructions manual and in combination with articles present in the Nice S.p.A. product catalogue. The electromagnetic compatibility may not be guaranteed if used in configurations or with other products that have not been foreseen the use of the product is prohibited in these situations until the correspondence to the requirements foreseen by the directive have been verified by those performing the installation.

2) Product description and applications

ROBUS is a line of irreversible electromechanical gearmotors for the automation of sliding gates. It is equipped with an electronic control unit and connector for the optional SMXI or SMXIS radiocontrol receiver. The electrical connections to external devices have been simplified through the use of "BlueBUS", a technique by which several devices can be connected up using just 2 wires. ROBUS oper-

ates with electric power. In the event of a power failure, the gearmotor can be released using a special key in order to move the gate manually. Alternatively, there is the PS124 buffer battery (optional accessory) which makes it possible to use the gate also during the event of a power failure.

Other products are also part of the ROBUS line, the difference of which is described in table 1.

Table 1: comparison of the ROBUS gearmotor main characteristics

| Gearmotor type | RB500 | RB500P | RB1000 | RB1000P |
|---------------------------|--|---------------------|---|---------------------|
| Limit switch type | electromechanical | inductive proximity | electromechanical | inductive proximity |
| Maximum leaf length | 8m | | 12m | |
| Maximum leaf weight | 500Kg | | 1000Kg | |
| Peak thrust | 18Nm | | 27Nm | |
| corresponding to a force) | (360N) | | (900N) | |
| Motor and transformer | Motor 24Vcc Ø 77mm El core-type transformer | | Motor 24Vcc Ø 115mm Toroidal transformer | |

Note: 1Kg = 9,81N for example: 600N = 61Kg

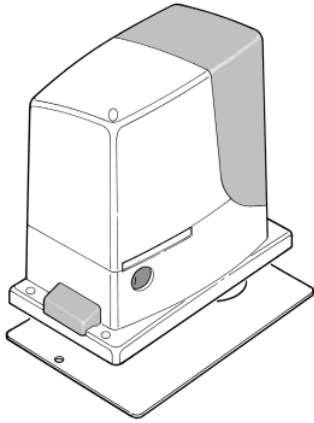

1

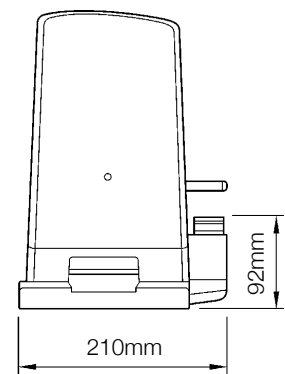
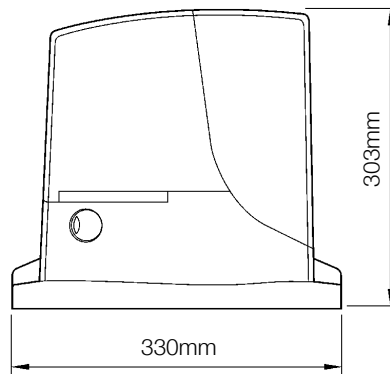

2.1) Operating limits

Chapter 8 "Technical Characteristics" provides the only data needed to determine whether the products of the ROBUS line are suitable for the intended application.

The structural characteristics of ROBUS make it suitable for use on sliding leaves in conformity with the limits indicated in tables 2, 3 and 4.

The effective suitability of ROBUS to automate a particular sliding gate depends on the friction as well as other correlated factors, such as ice, that could interfere with the movement of the leaf.

For an effective control it is absolutely vital to measure the force necessary to move the leaf throughout its entire run and ensure that this is less than half of the "nominal torque" indicated in chapter 8 "Technical characteristics" (a 50% margin on the force is recommended, as unfavourable climatic conditions may cause an increase in the friction); furthermore, it is necessary to take into consideration the

data indicated in tables 2 and 3 to establish the number of cycles/hour, consecutive cycles and maximum speed allowed.

2.2) Typical system

Figure 2 shows a typical system for automating a sliding gate using ROBUS

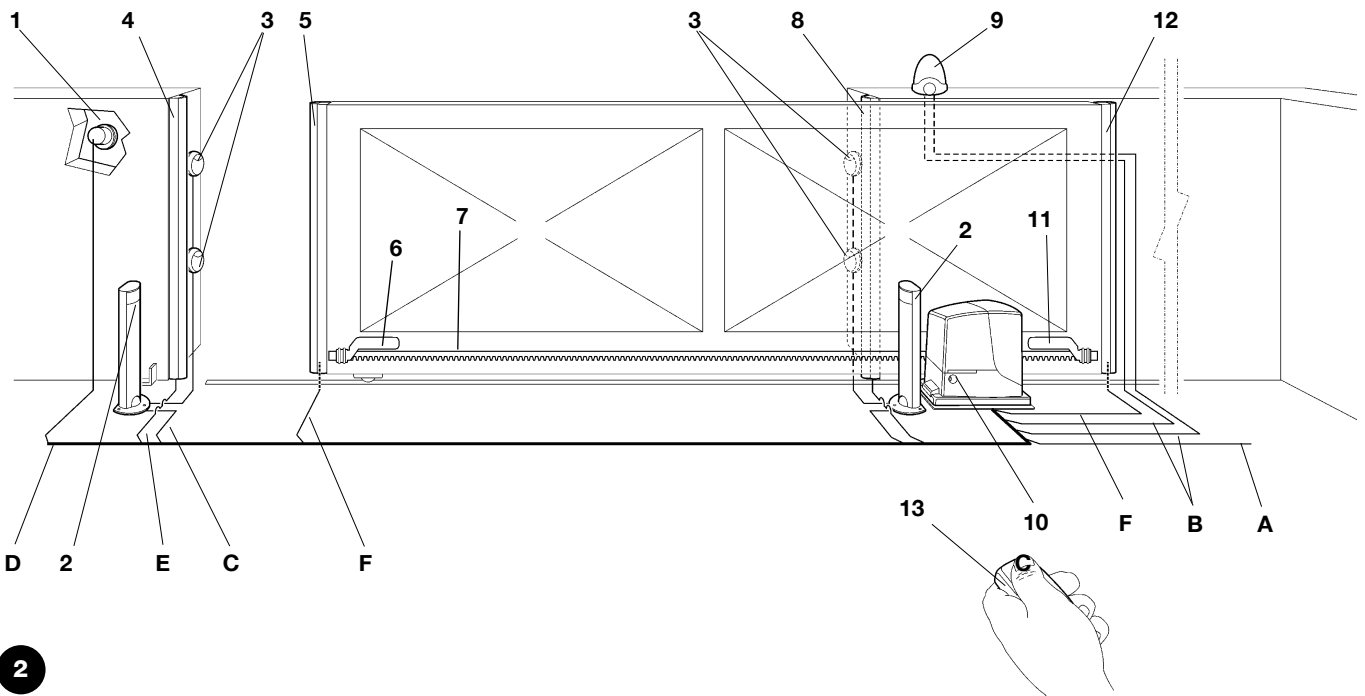

2

- | | |
|--------------------------------|---|
| 1 Key-operated selector switch | 8 Secondary fixed edge (optional) |
| 2 Photocells on post | 9 Flashing light with incorporated aerial |
| 3 Photocells | 10 ROBUS |
| 4 Main fixed edge (optional) | 11 "Closed" stop bracket |
| 5 Main movable edge | 12 Secondary movable edge (optional) |
| 6 "Open" stop bracket | 13 Radio-transmitter |
| 7 Rack | |

2.3) List of cables

Figure 2 shows the cables needed for the connection of the devices in a typical installation; table 5 shows the cable characteristics.

⚠ The cables used must be suitable for the type of installation; for example, an H03VV-F type cable is recommended for indoor applications, while H07RN-F is suitable for outdoor applications.

Table 5: List of cables

| Connection | Cable type | Maximum length allowed |
|--|---------------------------------------|---------------------------------|
| A: Power line | 1 3x1,5mm ² cable | 30m (note 1) |
| B: Flashing light with aerial | 1 2x0,5mm ² cable | 20m |
| | 1 RG58 type shielded cable | 20m (recommended less than 5 m) |
| C: Photocells | 1 2x0,5mm ² cable | 30m (note 2) |
| D: Key-operated selector switch | 2 2x0,5mm ² cable (note 3) | 50m |
| E: Fixed edges | 1 2x0,5mm ² cable (note 4) | 30m |
| F: Movable edges | 1 2x0,5mm ² cable (note 4) | 30m (note 5) |

Note 1: power supply cable longer than 30 m may be used provided it has a larger gauge, e.g. 3x2,5mm², and that a safety grounding system is provided near the automation unit.

Note 2: If the "BLUEBUS" cable is longer than 30 m, up to 50 m, a 2x1mm² cable is needed.

Note 3: A single 2x0,5mm² cable can be used instead of two 4x0,5mm² cables.

Note 4: Please refer to Chapter "7.3.2 STOP Input" in situations where there is more than one edge, for information about the type of connection recommended by the manufacturer.

Note 5: special devices which enable connection even when the leaf is moving must be used to connect movable edges to sliding leaves.

3) Installation

⚠ The installation of ROBUS must be carried out by qualified personnel in compliance with current legislation, standards and regulations, and the directions provided in this manual.

3.1) Preliminary checks

Before proceeding with the installation of ROBUS you must:

- Check that all the materials are in excellent condition, suitable for use and that they conform to the standards currently in force.
- Make sure that the structure of the gate is suitable for automation.
- Make sure that the weight and dimensions of the leaf fall within the specified operating limits provided in chapter "2.1 Operating limits".
- Check that the force required to start the movement of the leaf is less than half the "maximum torque", and that the force required to keep the leaf in movement is less than half the "nominal torque". Compare the resulting values with those specified in Chapter "8 Technical Characteristics". The manufacturers recommend a 50% margin on the force, as unfavourable climatic conditions may cause an increase in the friction.
- Make sure that there are no points of greater friction in the opening or closing travel of the gate leaves.
- Make sure there is no danger of the gate derailing.
- Make sure that the mechanical stops are sturdy enough and that there is no risk of the deformation even when the leaf hits the mechanical stop violently.
- Make sure that the gate is well balanced: it must not move by itself when it is placed in any position.
- Make sure that the area where the gearmotor is fixed is not subject to flooding. If necessary, mount the gearmotor raised from the ground.

- Make sure that the installation area enables the release of the gearmotor and that it is safe and easy to release it.
- Make sure that the mounting positions of the various devices are protected from impacts and that the mounting surfaces are sufficiently sturdy.
- Components must never be immersed in water or other liquids.
- Keep ROBUS away from heat sources and open flames; in acid, saline or potentially explosive atmosphere; this could damage ROBUS and cause malfunctions or dangerous situations.
- If there is an access door in the leaf, or within the range of movement of the gate, make sure that it does not obstruct normal travel. Mount a suitable interblock system if necessary.
- Only connect the control unit to a power supply line equipped with a safety grounding system.
- The power supply line must be protected by suitable magneto-thermal and differential switches.
- A disconnection device must be inserted in the power supply line from the electrical mains (the distance between the contacts must be at least 3.5 mm with an overvoltage category of III) or equivalent system, for example an outlet and relative plug. If the disconnection device for the power supply is not mounted near the automation, it must have a locking system to prevent unintentional, unauthorised connection.

3.2) Installation of the gearmotor

The gearmotor must be fastened directly to an already existing mounting surface using suitable means, for example expansion screw anchors. Otherwise, in order to fasten the gearmotor the installer must:

1. Dig a foundation hole with suitable dimensions referring to Figure 3.
2. Prepare one or more conduits for the electrical cables as shown in figure 4.
3. Assemble the two clamps on the foundation plate setting one nut underneath and one on top of the plate. The nut underneath the plate must be as shown in Figure 5 screwed so that the thread-

ed part protrudes above the plate by approximately 25÷35 mm.

4. Pour the concrete and, before it starts to harden, set the foundation plate to the values shown in Figure 3. Check that it is parallel to the leaf and perfectly level (Figure 6). Wait for the concrete to harden completely.
5. Remove the 2 upper nuts of the plate and then place the gearmotor onto them. Check that it is perfectly parallel to the leaf, then screw the two nuts and washers supplied, as shown in Figure 7.

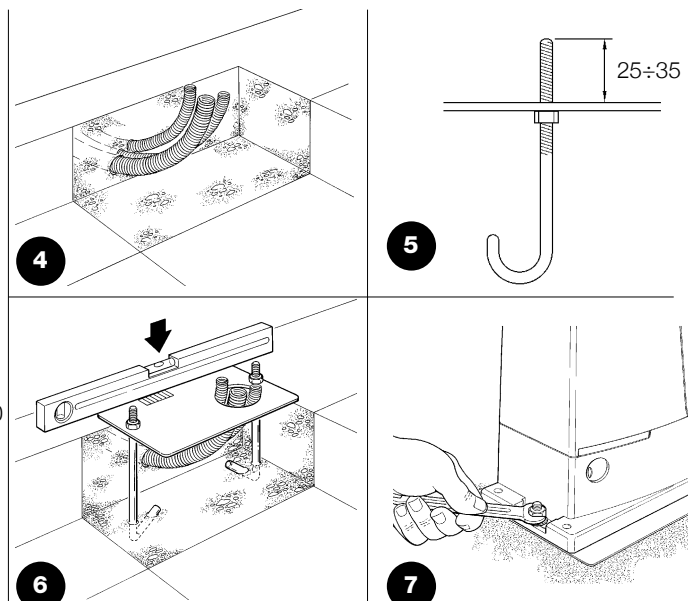
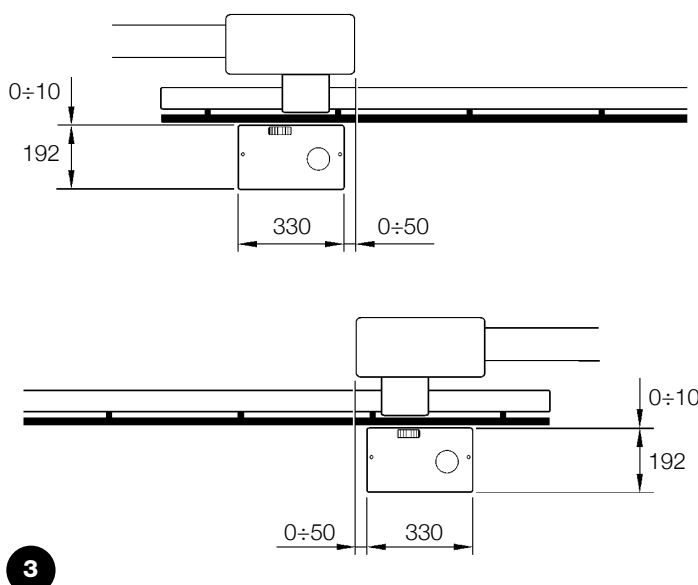

If the rack is already present, once the gearmotor has been fastened, use the adjustment dowels as shown in Figure 8 to set the pinion of ROBUS to the right height, leaving 1÷2 mm of play from the rack. Otherwise, in order to fasten the rack the installer must:

6. Release the gearmotor as shown in “Release and manual movement” paragraph in the Chapter “Instructions and Warnings for users of the ROBUS gearmotor”.

7. Open the leaf up completely and place the first piece of the rack on the pinion. Check that the beginning of the rack corresponds to the beginning of the leaf, as shown in Figure 9. Leave a 1÷2 mm play between the rack and the pinion, then fasten the rack to the leaf using suitable means.

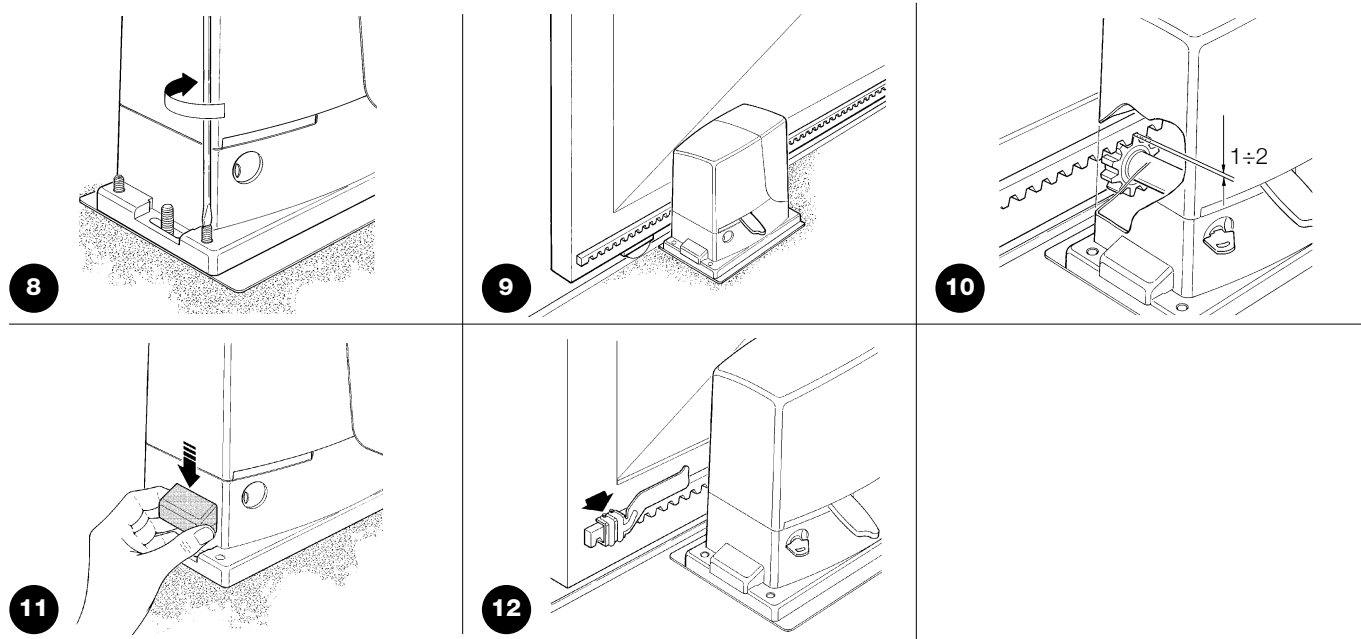

⚠ In order to prevent the weight of the leaf from affecting the gearmotor, it is important that there is a play of 1÷2 mm between the rack and the pinion as shown in Figure 10.

- 8. Slide the leaf, using the pinion as a reference point for the fastening the other elements of the rack.
- 9. Cut away the exceeding part of the rack.
- 10. Open and close the gate several times and make sure that the rack is aligned with the pinion with a maximum tolerance of 5 mm. Moreover, check that the play of 1÷2 mm has been respected along the entire length between the pinion and the rack.
- 11. Thoroughly tighten the two fixing nuts of the gearmotor making sure it is well fastened to the ground. Cover the fixing nuts with the relative caps as shown in figure 11.

12. Fix the limit switch bracket as described below (for versions RB600P and RB1000P, fix the bracket as described in paragraph “3.3 Fixing of the limit switch bracket on versions with inductive limit switch”):

- Manually place the leaf in the open position leaving at least 2-3 cm from the mechanical stop.
 - Slide the bracket along the rack in the opening direction until the limit switch cuts-in. Then bring the bracket forward by at least 2 cm and secure it to the rack with the appropriate dowels, as in fig. 12.
 - Perform the same operation for the closure limit switch.
13. Lock the gearmotor as shown in “Release and manual movement” paragraph in the Chapter “Instructions and Warnings for Users”

3.3) Fixing of the limit switch bracket on versions with inductive limit switch

The limit switch bracket must be fixed as described below for the RB600P and RB1000P versions that utilise the inductive limit switch.

- 1. Manually place the leaf in the open position leaving at least 2-3 cm from the mechanical stop.
- 2. Slide the bracket along the rack in the opening direction until the corresponding LED switches off, as in fig. 13. Then bring the bracket forward by at least 2 cm and secure it to the rack with the appropriate dowels.
- 3. Manually place the leaf in the closed position leaving at least 2-3 cm from the mechanical stop
- 4. Slide the bracket along the rack in the closing direction until the corresponding LED switches off. Then bring the bracket forward by at least 2 cm and secure it to the rack with the appropriate dowels.

⚠ The ideal distance of the bracket for inductive limit switches is between 3 and 8 mm as indicated in fig. 14.

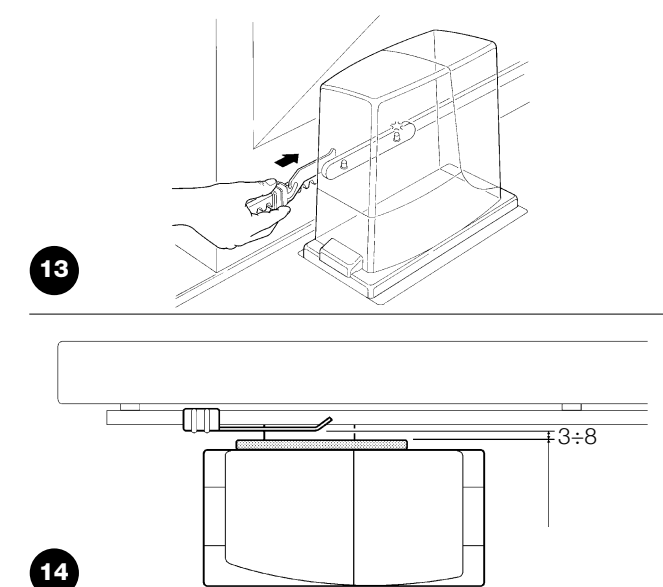

3.4) Installation of the various devices

If other devices are needed, install them following the directions provided in the corresponding instructions. Check this in paragraph "3.6 Description of electrical connections" and the devices which can be connected to the ROBUS in Figure 2.

3.5) Electrical connections

⚠ Only carry out electrical connections once the electricity supply to the system has been switched off. Disconnect any buffer batteries present.

1. Remove the protection cover in order to access the electronic control unit of the ROBUS. The side screw must be removed, and the cover lifted upwards.
2. Remove the rubber membrane which closes the hole for passage of the cables and insert all the connection cables towards the various devices, leaving a length of 20÷30 cm longer than necessary. See Table 5 for information regarding the type of cables and Figure 2 for the connections.
3. Use a clamp to collect together and join the cables which enter the gear-motor. Place the clamp just underneath the hole the cables enter through.

Make a hole in the rubber membrane which is slightly smaller than the diameter of the cables which have been collected together, and insert the membrane along the cables until you reach the clamp. Then put the membrane back in the slot of the hole the cables pass through. Lay a second clamp for collecting the cables which are set just above the membrane.

4. Connect the power cable to the appropriate terminal as shown in figure 15, then block the cable at the first cable block ring using the clamp.
5. Connect up the other cables according to the diagram in Figure 17. The terminals can be removed in order to make this work easier.
6. Once the connections have been completed, block the cables collected in the second cable block ring using clamps. The excess of the aerial cable must be blocked to the other cables using another clamp as shown in Figure 16.

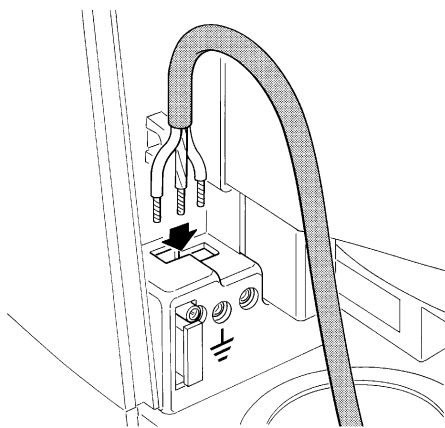

15

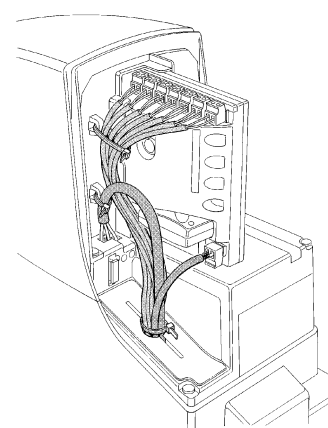

16

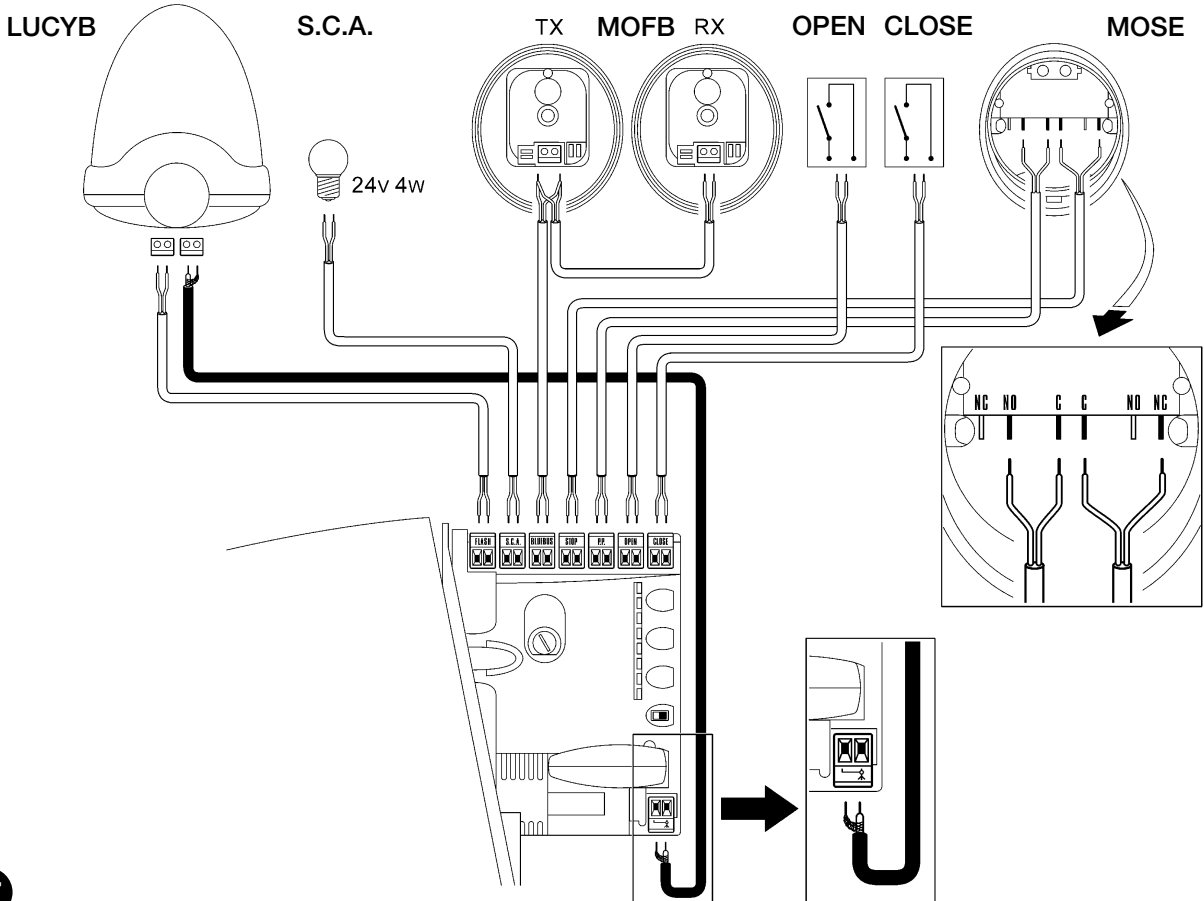

17

See paragraph "7.3.5 ROBUS in Slave mode" for the connection of 2 motors on opposite leaves.

3.6) Description of the electrical connections

The following is a brief description of the electrical connections; for further information please read "7.3 Adding or Removing Devices" paragraph.

FLASH: output for one or two "LUCYB" or similar type flashing lights with single 12V maximum 21W bulb.

S.C.A.: "Open Gate Light" output. An indication lamp can be connected (24V max. 4W). It can also be programmed for other functions; see paragraph "7.2.3 Level two functions".

BLUEBUS: compatible devices can be connected up to this terminal. They are connected in parallel using two conductors only, through which both the electricity supply and the communication signals travel. For more useful information about BlueBUS see also Paragraph "7.3.1 BlueBUS".

STOP: input for the devices which block or eventually stop the manoeuvre in progress. Contacts like "Normally Closed", "Normally Open" or constant resistance devices can be connected up using special procedures on the input. For more useful information about

STOP see also Paragraph "7.3.2 STOP Input".

STEP-BY-STEP: input for devices which control Step-by-Step movement. It is possible to connect "Normally Open" devices up to this input.

OPEN: input for devices which control only the opening movement. It is possible to connect "Normally Open" devices up to this input.

CLOSE: input for devices which control only the closing movement. It is possible to connect "Normally Open" devices up to this input.

AERIAL: connection input for the radio receiver aerial (the aerial is incorporated in LUCY B).

4) Final checks and start up

The manufacturers recommend you position the leaf at approximately half travel before starting the checking and start up phase of the automation. This will ensure the leaf is free to move both during opening and closure.

4.1) Choosing the direction

The direction of the opening manoeuvre must be chosen depending on the position of the gearmotor with respect to the leaf. If the leaf must move left for opening, the selector must be moved towards left as shown in Figure 18; alternatively, if the leaf has to move right during opening, the selector must be moved towards the right as shown in Figure 19

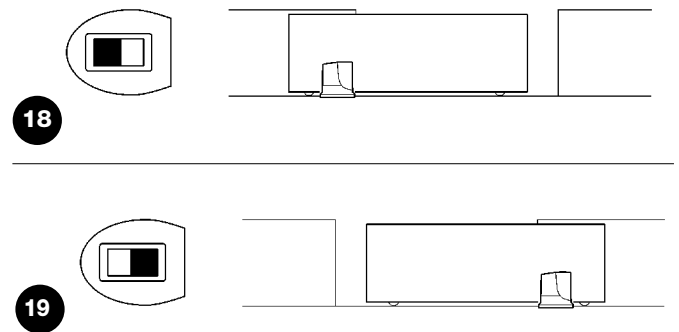

4.2) Power supply connection

⚠ The connection of ROBUS to the mains must be made by qualified and experienced personnel in possession of the necessary requisites and in full respect of the laws, provisions and standards currently in force.

As soon as ROBUS is energized, you should check the following:

1. Make sure that the "BLUEBUS" LED flashes regularly, with about one flash per second.
2. Make sure that the LED's on the photocells flash (both on TX and RX); the type of flashing is not important as it depends on other factors.

3. Make sure that the flashing light connected to the FLASH output and the lamp LED connected to the "Open Gate Indicator" output are off.

If the above conditions are not satisfied, you should immediately switch off the power supply to the control unit and check the electrical connections more carefully.

Please refer to Chapter "7.6 Troubleshooting" for further information about finding and analysing failures.

4.3) Recognition of the devices

After connecting up the power supply, the control unit must be made to recognise the devices connected up to the BLUEBUS and STOP inputs. Before this phase, LEDs L1 and L2 will flash to indicate that recognition of the devices must be carried out.

1. Press keys **[▲]** and **[Set]** and hold them down
2. Release the keys when L1 and L2 LED's start flashing very quickly (after approx. 3 s)
3. Wait a few seconds for the control unit to finish recognizing the devices
4. When the recognition stage is completed the STOP LED must remain on while the L1 and L2 LED's must go off (LEDs L3 and L4 will eventually start flashing).

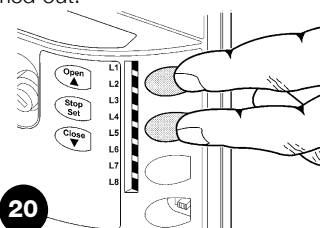

The connected devices recognition stage can be repeated at any time, even after the installation (for example, if a device is installed); for performing the new recognition see paragraph "7.3.6 Recognition of Other Devices".

4.4) Recognizing the length of the leaf

After recognizing the devices, L3 and L4 LED's start flashing; the control unit must recognize the length of the gate. During this stage, the length of the leaf is measured from the closing limit switch to the opening limit switch. This measurement is required to calculate the deceleration points and the partial opening point.

1. Press keys **[▼]** and **[Set]** and hold them down
2. Release the keys when the manoeuvre starts (after approx. 3 s)
3. Check the manoeuvre in progress is an opening manoeuvre. Otherwise, press the **[Stop]** key and carefully check Paragraph "4.1 Choosing the Direction", then repeat the process from Point 1.
4. Wait for the control unit to open the gate until it reaches the opening limit switch; the closing manoeuvre will start immediately afterwards.
5. Wait for the control unit to close the gate.

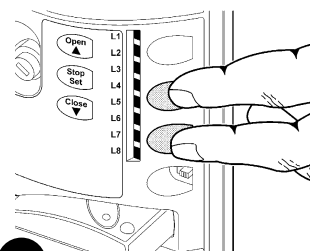

21

If the above conditions are not satisfied, you should immediately switch off the power supply to the control unit and check the electrical connections more carefully. For more useful information see also chapter "7.6 Troubleshooting".

4.5) Checking gate movements

On completion of the recognition of the length of the leaf, it is advisable to carry out a number of manoeuvres in order to check the gate travels properly.

1. Press the **[Open]** key to open the gate. Check that gate opening occurs regularly, without any variations in speed. The leaf must only slowdown and stop when it is between 70 and 50 cm from the opening mechanical stop. Then, at 2÷3 cm from the mechanical opening stop the limit switch will trigger.
2. Press the **[Close]** key to close the gate. Check that gate closing occurs regularly, without any variations in speed. The leaf must only slowdown and stop when it is between 70 and 50 cm from the closing mechanical stop. Then, at 2÷3 cm from the mechanical closing stop the limit switch will trigger.
3. During the manoeuvre, check that the flashing light flashes at a speed of 0.5 seconds on and 0.5 seconds off. If present, also check the flashes of the light connected to the S.C.A. terminal: slow flashes during opening, quick flashes during closing.
4. Open and close the gate several times to make sure that there are no points of excessive friction and that there are no defects in the assembly or adjustments.
5. Check that the fastening of the ROBUS gearmotor, the rack and the limit switch brackets are solid, stable and suitably resistant, even if the gate accelerates or decelerates sharply.

4.6) Preset functions

The ROBUS control unit has a number of programmable functions. These functions are set to a configuration which should satisfy most automations. However, the functions can be altered at any time by means of a special programming procedure.

Please refer to paragraph "7.2 Programming" for further information about this.

4.7) Radio receiver

The "SM" radio receiver connector for SMXI or SMXIS type optional radio receivers has been provided in order to enable the user to control ROBUS from a distance. For further information consult the radio receiver instructions manual. The association between the radio receiver output and the command performed by ROBUS is described in table 6:

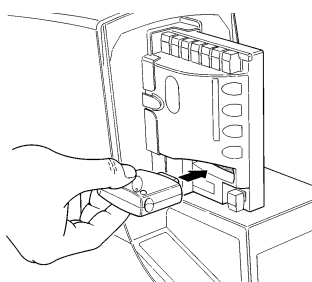

22

Table 6: commands with transmitter

| | |
|------------|---------------------------|
| Output N°1 | STEP-BY-STEP command |
| Output N°2 | "Partial opening" command |
| Output N°3 | "Open" command |
| Output N°4 | "Close" command |

5) Testing and commissioning

This is the most important stage in the automation system installation procedure in order to ensure the maximum safety levels. Testing can also be adopted as a method of periodically checking that all the various devices in the system are functioning correctly.

⚠ Testing of the entire system must be performed by qualified and experienced personnel who must establish which tests to conduct on the basis of the risks involved, and verify the compliance of the system with applicable regulations, legislation and standards, in particular with all the provisions of EN standard 12445 which establishes the test methods for automation systems for gates.

5.1) Testing

Each component of the system, e.g. safety edges, photocells, emergency stop, etc. requires a specific testing phase. We therefore recommend observing the procedures shown in the relative instruction manuals. To test ROBUS proceed as follows:

1. Ensure that the instructions outlined in this manual and in particular in chapter 1 "WARNINGS" have been observed in full;
2. Release the gearmotor as shown in "Release and manual movement" paragraph in chapter "Instructions and Warnings for users of the ROBUS gearmotor"
3. Make sure you can move the door manually both during opening and closing with a force of max. 390N (40 kg approx.).
4. Lock the gearmotor.
5. Using the control or stop devices (key-operated selector switch, control buttons or radio transmitter) test the opening, closing and stopping of the gate and make sure that the leaves move in the intended direction.
6. Check the proper operation of all the safety devices, one by one (photocells, sensitive edges, emergency stop, etc.) and check that the gate performs as it should. In particular, each time a device is activated the "BlueBUS" LED on the control unit flashes 2 times quickly, confirming that the control unit recognizes the event.
7. If the dangerous situations caused by the movement of the leaf have been safeguarded by limiting the force of impact, the user must measure the impact force according to EN Standard 12445. If the adjustment of the "speed" and control of the "motor force" are used to assist the system for the reduction of the impact force, try to find the adjustment that gives the best results.

5.2) Commissioning

Commissioning can take place only after all the testing phases of the ROBUS and the other devices have been terminated successfully. It is not permissible to execute partial commissioning or to enable use of the system in makeshift conditions.

1. Prepare and store for at least 10 years the technical documentation for the automation, which must include at least: assembly drawing of the automation, wiring diagram, analysis of hazards and solutions adopted, manufacturer's declaration of conformity of all the devices installed (for ROBUS use the annexed CE declaration of conformity); copy of the instruction manual and maintenance schedule of the automation.
2. Post a label on the gate providing at least the following data: type of automation, name and address of manufacturer (person responsible for the "commissioning"), serial number, year of manufacture and "CE" marking.
3. Post a permanent label or sign near the gate detailing the operations for the release and manual manoeuvre.
4. Prepare the declaration of conformity of the automation system and deliver it to the owner.
5. Prepare the "Instructions and warnings for the use of the automation system" and deliver it to the owner.
6. Prepare the maintenance schedule of the automation system and deliver it to the owner; it must provide all directions regarding the maintenance of the single automation devices.
7. Before commissioning the automation system inform the owner in writing regarding dangers and hazards that are still existing (e.g. in the "Instructions and warnings for the use of the automation system").

6) Maintenance and Disposal

This charter provides information about how to draw up a maintenance schedule, and the disposal of ROBUS

6.1) Maintenance

The automation must be subjected to maintenance work on a regular basis, in order to guarantee it lasts; to this end ROBUS has a manoeuvre counter and maintenance warning system; see paragraph "7.4.3 Maintenance warning"

⚠ The maintenance operations must be performed in strict compliance with the safety directions provided in this manual and according to the applicable legislation and standards.

If other devices are present, follow the directions provided in the corresponding maintenance schedule.

1. ROBUS requires scheduled maintenance work every 6 months or 20,000 manoeuvres (max.) after previous maintenance:
2. Disconnect the power supply (and buffer batteries, if featured)
3. Check for any deterioration of the components which form the automation, paying particular attention to erosion or oxidation of the structural parts. Replace any parts which are below the required standard.
4. Check the wear and tear on the moving parts: pinion, rack and the leaf components; if necessary replace them.
5. Connect the electric power sources up again, and carry out the testing and checks provided for in Paragraph "5.1 Testing".

6.2) Disposal

ROBUS is constructed of various types of materials, some of which can be recycled: steel, aluminium, plastic, electric cables; while others must be disposed of (batteries and electronic boards).

⚠ Some electronic components and the batteries may contain polluting substances; do not pollute the environment. Enquire about the recycling or disposal systems available in compliance regulations locally in force.

1. Disconnect the power supply of the automation system (and the buffer battery, if featured).
2. Disassemble all the devices and accessories, following in reverse order the procedures described in chapter 3 "Installation".
3. Wherever possible, separate any parts which can or must be recycled or disposed of in different ways, e.g. metal parts must be disposed of separately from plastic ones, as must the electronic cards, batteries etc.
4. Sort the various materials and consign them to local licensed firms for recovery and disposal.

7) Additional information

Programming, personalisation and how to look for and deal with faults on the ROBUS will be dealt with in this chapter.

7.1) Programming keys

The ROBUS control unit feature three keys that can be used to command the control unit both during tests and programming.

| | |
|-------------------|--|
| Open ▲ | The "OPEN" key enables the user to control the opening of the gate or move the programming point upwards. |
| Stop Set | The "STOP" key enables the user to stop the manoeuvre. If pressed down for more than 5 seconds it enables the user to enter programming. |
| Close ▼ | The "CLOSE" key enables the user to control the closing of the gate or move the programming point downwards. |

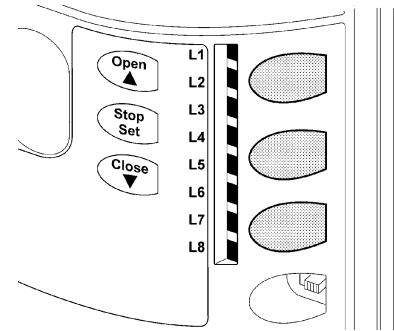

23

7.2) Programming

A number of programmable functions are available on the ROBUS control unit. The functions are adjusted using 3 keys set on the control unit: [▲] [Set] [▼] and are used by means of 8 LEDs: L1...L8.

The programmable functions available on ROBUS are set out on 2 levels:

Level one: the functions can be adjusted in modes ON-OFF (active or inactive). In this case, each of the LEDs L1...L8 indicates a function. If the LED is on, the function is active, if off the function is inactive. See Table 7.

Level two: the parameters can be adjusted on a scale of values (from 1 to 8). In this case, each of the LEDs L1...L8 indicates the value set (there are 8 possible settings). Please refer to Table 9.

7.2.1) Level one functions (ON-OFF functions).

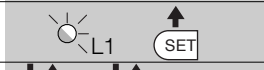



Table 7: programmable function list: level one

| Led | Function | Description |
|-----|----------------------------------|---|
| L1 | Automatic Closing | This function causes the door to close automatically after the programmed time has lapsed. The factory set Pause Time is 30 seconds, but can be changed to 5, 15, 30, 45, 60, 80, 120 or 180 seconds. If the function is inactive, functioning will be "semi-automatic". |
| L2 | Close After Photo | This function enables the gate to be kept open for the necessary transit time only. In fact the "Photo" always causes an automatic closure with a pause time of 5s (regardless of the programmed value). The action changes depending on whether the "Automatic closing" function is active or not. When "Automatic Closing" is inactive: The gate always arrives to the totally open position (even if the Photo disengages first). Automatic closing with a pause of 5s occurs when the Photo is disengaged. When "Automatic Closing" is active: The opening manoeuvre stops immediately after the photocells have disengaged. After 5 seconds, the gate will begin to close automatically. The "Close after photo" function is always disabled in manoeuvres interrupted by a Stop command. If the "Close after photo" function is inactive the pause time is that which has been programmed or there is no automatic closing if the function is inactive. |
| L3 | Always Close | The "Always Close" function will trigger, and the gate will close if an open gate is detected when the power supply returns. If the function is inactive when the power supply returns, the gate will remain still. |
| L4 | Stand-By | Stand-By This function enables the user to lower consumption to a very minimum. It is particularly useful in cases when the buffer battery is being used. If this function is active, the control unit will switch the BLUEBUS output (and consequently the devices) and all the LEDs off one minute after the end of the manoeuvre. The only LED which will remain on is the BLUEBUS LED which will simply flash more slowly. When a command arrives, the control unit will reset to complete functioning. If this function is inactive, there will be no reduction in the consumption. |
| L5 | Peak | If this function is activated, the gradual acceleration at the beginning of each manoeuvre will be disconnected. It enables the peak thrust and is useful whenever static friction is high, e.g. if snow or ice are blocking the leaf. If the thrust is inactive, the manoeuvre will start with a gradual acceleration. |
| L6 | Pre-flashing | With the pre-flashing function, a 3 second pause is added between the flashing light switching on and the beginning of the manoeuvre in order to warn the user, in advance, of a potentially dangerous situation. If pre-flashing is inactive, the flashing light will switch on when the manoeuvre starts. |
| L7 | "Close" becomes "Open partially" | By activating this function all "close" commands ("CLOSE" input or radio command "close") activate a partial opening manoeuvre (see LED L6 on table 9). |
| L8 | "Slave" mode | By activating this function ROBUS becomes "Slave": in this way it is possible to synchronise the functioning of two motors on opposite leaves where one motor functions as Master and the other as Slave; for further information see paragraph "7.3.5 ROBUS in "Slave" mode". |

During the normal functioning of the ROBUS, LEDs L1...L8 will either be on or off depending on the state of the function they represent. For example, L1 will be on if the "Automatic Closing" function is active.

7.2.2 Level one programming (ON-OFF functions).

Level 1 functions are all factory set to "OFF". However, they can be changed at any time as shown in Table 8. Follow the procedure carefully, as there is a maximum time of 10 seconds between pressing one key and another. If a longer period of time lapses, the procedure will finish automatically and memorize the modifications made up to that stage.

| Table 8: changing ON-OFF functions | | Example |
|------------------------------------|--|---|
| 1. | Press the key [Set] and hold it down (approx. 3 s) |  |
| 2. | Release the [Set] key when L1 LED starts flashing |  |
| 3. | Press keys [▲] or [▼] to move the flashing LED onto the LED representing the function which is to be changed |  |
| 4. | Press the [Set] key to change the state of the function (short flashing = OFF; long flashing = ON) |  |
| 5. | Wait 10 seconds before leaving the programme to allow the maximum time to lapse. |  |

Note: Points 3 and 4 can be repeated during the same programming phases in order to set other functions to ON or OFF

7.2.3 Level two functions (adjustable parameters)

| Table 9: programmable function list: level two | | | | |
|--|----------------------------|-------------|--|---|
| Input LED | Parameter | LED (level) | value | Description |
| L1 | Pause Time | L1 | 5 seconds | Adjusts the pause time, namely the time which lapses before automatic closure. This will only have an effect if automatic closing is active. |
| | | L2 | 15 seconds | |
| | | L3 | 30 seconds | |
| | | L4 | 45 seconds | |
| | | L5 | 60 seconds | |
| | | L6 | 80 seconds | |
| | | L7 | 120 seconds | |
| | | L8 | 180 seconds | |
| L2 | Step-by-step | L1 | Open – stop – close - stop | Manages the sequence of controls associated to the Step-by-Step input or to the 1st radio command. |
| | | L2 | Open – stop – close - open | |
| | | L3 | Open – close – open - close | |
| | | L4 | Condominium operation | |
| | | L5 | Condominium operation 2 (more than 2" causes stop) | |
| | | L6 | Step-by-Step 2 (less than 2" causes partial opening) Uomo presente | |
| | | L7 | Man present | |
| | | L8 | "Semiautomatic" opening, "Man present " closing | |
| L3 | Motor speed | L1 | Very slow | Adjusts the speed of the motor during normal travel. |
| | | L2 | Slow | |
| | | L3 | Medium | |
| | | L4 | Fast | |
| | | L5 | Very fast | |
| | | L6 | Extremely Fast | |
| | | L7 | Opens "Fast"; closes "slow" | |
| | | L8 | Opens "Extremely Fast" Closes "Fast" | |
| L4 | Open Gate Indicator Output | L1 | Open Gate Indicator Function | Adjusts the function associated with the S.C.A. output (whatever the associated function may be, the output supplies a voltage of 24V –30 +50% with a maximum power of 4W when active). |
| | | L2 | On if leaf closed | |
| | | L3 | On if leaf open | |
| | | L4 | Active with 2nd radio output | |
| | | L5 | Active with 3rd radio output | |
| | | L6 | Active with 4th radio output | |
| | | L7 | Maintenance indicator | |
| | | L8 | Electric lock | |
| L5 | Motor force | L1 | Super light gate | Adjusts the system which controls the motor force in order to adapt it to the weight of the gate. The force control system also measures the ambient temperature, automatically increasing the force in the event of particularly low temperatures. |
| | | L2 | "Very light" gate | |
| | | L3 | "Light" gate | |
| | | L4 | "Average" gate | |
| | | L5 | "Average-heavy" gate | |
| | | L6 | "Heavy" gate | |
| | | L7 | "Very heavy" gate | |
| | | L8 | "Super heavy" gate | |

| Led di entrata | Parametro | Led (livello) | Valore | Descrizione |
|----------------|----------------------|---------------|--|--|
| L6 | Open Partially | L1 | 0,5 m | Adjusts the measurement of the partial opening. Partial opening can be controlled with the 2nd radio command or with "CLOSE", if the "Close" function is present, this becomes "Open partially". |
| | | L2 | 1 m | |
| | | L3 | 1,5 m | |
| | | L4 | 2 m | |
| | | L5 | 2,5 m | |
| | | L6 | 3 m | |
| | | L7 | 3,4 m | |
| | | L8 | 4 m | |
| L7 | Maintenance warning | L1 | Automatic (depending on the severity of the manoeuvre) | Adjusts the number of manoeuvres after which it signals the maintenance request of the automation (see paragraph "7.4.3 Maintenance warning"). |
| | | L2 | 1000 | |
| | | L3 | 2000 | |
| | | L4 | 4000 | |
| | | L5 | 7000 | |
| | | L6 | 10000 | |
| | | L7 | 15000 | |
| | | L8 | 20000 | |
| L8 | List of malfunctions | L1 | 1ª manoeuvre result | The type of defect that has occurred in the last 8 manoeuvres can be established (see paragraph "7.6.1 Malfunctions archive"). |
| | | L2 | 2ª manoeuvre result | |
| | | L3 | 3ª manoeuvre result | |
| | | L4 | 4ª manoeuvre result | |
| | | L5 | 5ª manoeuvre result | |
| | | L6 | 6ª manoeuvre result | |
| | | L7 | 7ª manoeuvre result | |
| | | L8 | 8ª manoeuvre result | |









Note: "■" represents the factory setting

All the parameters can be adjusted as required without any contraindication; only the adjustment of the "motor force" could require special care:

- Do not use high force values to compensate for points of abnormal friction on the leaf. Excessive force can compromise the operation of the safety system or damage the leaf.
- If the "motor force" control is used to assist the impact force reduction system, measure the force again after each adjustment in compliance with EN standard 12445.
- Wear and weather conditions may affect the movement of the gate, therefore periodic force re-adjustments may be necessary.

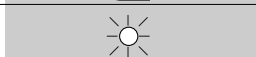
7.2.4) Level two programming (adjustable parameters)

The adjustable parameters are factory set as shown in the table 9, with: "■" However, they can be changed at any time as shown in Table 10. Follow the procedure carefully, as there is a maximum time of 10 seconds between pressing one key and another. If a longer period of time lapses, the procedure will finish automatically and memorize the modifications made up to that stage.

| Table 10: changing the adjustable parameters | Example |
|---|---|
| 1. Press the key [Set] and hold it down (approx. 3 s |  |
| 2. Release the [Set] key when L1 LED starts flashing |  |
| 3. Press key [▲] or [▼] to move the flashing LED onto the input LED representing the parameter which is to be changed |  |
| 4. Press the key [Set] , and hold it down during step 5 and 6 |  |
| 5. Wait approx. 3 seconds, after which the LED representing the current level of the parameter which is to be modified will light up. |  |
| 6. Press key [▲] or [▼] to move the LED representing the parameter value. |  |
| 7. Release the key [Set] |  |
| 8. Wait 10 seconds before leaving the programme to allow the maximum time to lapse. |  |

Note: Points 3 to 7 can be repeated during the same programming phase in order to set other parameters

7.2.5) Level one programming example (ON-OFF functions).

The sequence to follow in order to change the factory settings of the functions for activating “Automatic Closing” (L1) and “Always close” (L3) have been included as examples.

| Tabella 11: Level one programming example | Example |
|---|---------|
| 1. Press the key [Set] and hold it down (approx. 3 s) | |
| 2. Release the [Set] key when L1 LED starts flashing | |
| 3. Press the [Set] key once to change the state of the function associated with L1 (Automatic Closing). LED L1 will now flash with long flashes. | |
| 4. Press the [▼] key twice to move the flashing LED to LED L3 | |
| 5. Press the [Set] key once to change the state of the function associated with L3 (Always Close). LED L3 will now flash with long flashes. | |
| 6. Wait 10 seconds before leaving the programme to allow the maximum time to lapse. | |

Once these operations have been completed, LEDs L1 and L3 must remain on to indicate that the “Automatic Closing” and the “Always Close” functions are active.

7.2.6) Level two programming example (adjustable parameters)

The sequence to follow in order to change the factory settings of the parameters increasing the “Pause Time” to 60 seconds (input on L1 and level on L5) and reducing the “Motor Force” for light gates (input on L5 and level on L2) have been included as examples

| Table 12: Level two programming example | Example |
|---|---------|
| 1. Press the key [Set] and hold it down (approx. 3 s) | |
| 2. Release the [Set] key when L1 LED starts flashing | |
| 3. Press the key [Set] and hold it down during step 4 and 5 | |
| 4. Wait approx. 3 seconds until LED L3, representing the current level of the “Pause Time” will light up | |
| 5. Press the [▼] key twice to move the LED which is lit to LED L5, which represents the new “Pause Time” value | |
| 6. Release the key [Set] | |
| 7. Press the [▼] key four times to move the flashing LED to LED L5 | |
| 8. Press the key [Set] ; and hold it down during step 9 and 10 | |
| 9. Wait approx. 3 seconds until LED L5, representing the current level of the “Motor Force” will light up | |
| 10. Press the [▲] key three times to move the LED which is lit to LED L2, which represents the new “Motor Force” value | |
| 11. Release the key [Set] | |
| 12. Wait 10 seconds before leaving the programme to allow the maximum time to lapse. | |

7.3) Adding or removing devices

Devices can be added to or removed from the ROBUS automation system at any time. In particular, various devices types can be connected to “BlueBUS” and “STOP” input as explained in the following paragraphs.

After you have added or removed any devices, the automation system must go through the recognition process again according to the directions contained in paragraph 7.3.6 “Recognition of other devices”.

7.3.1) BlueBUS

BlueBUS technology allows you to connect compatible devices using only two wires which carry both the power supply and the communication signals. All the devices are connected in parallel on the 2 wires of the BlueBUS itself. It is not necessary to observe any polarity; each device is individually recognized because a univocal address is assigned to it during the installation. Photocells, safety devices, control keys, signalling lights etc. can be connected to BlueBUS. The ROBUS control unit recognizes all the connected

devices individually through a suitable recognition process, and can detect all the possible abnormalities with absolute precision. For this reason, each time a device connected to BlueBUS is added or removed the control unit must go through the recognition process; see paragraph 7.3.6 “Recognition of Other Devices”.

7.3.2) STOP input

STOP is the input that causes the immediate interruption of the manoeuvre (with a short reverse run). Devices with output featuring normally open "NO" contacts and devices with normally closed "NC" contacts, as well as devices with 8,2KΩ, constant resistance output, like sensitive edges, can be connected to this input.

During the recognition stage the control unit, like BlueBUS, recognizes the type of device connected to the STOP input (see paragraph 7.3.6 "Recognition of Other Devices"); subsequently it commands a STOP whenever a change occurs in the recognized status. Multiple devices, even of different type, can be connected to the STOP input if suitable arrangements are made.

- Any number of NO devices can be connected to each other in parallel.
- Any number of NC devices can be connected to each other in series.

- Two devices with 8,2KΩ constant resistance output can be connected in parallel; if needed, multiple devices must be connected "in cascade" with a single 8,2KΩ.
- It is possible to combine Normally Open and Normally Closed by making 2 contacts in parallel with the warning to place an 8,2KΩ resistance in series with the Normally Closed contact (this also makes it possible to combine 3 devices: Normally Open, Normally Closed and 8,2KΩ).

⚠ If the STOP input is used to connect devices with safety functions, only the devices with 8,2KΩ constant resistance output guarantee the fail-safe category 3 according to EN standard 954-1.

7.3.3) Photocells

By means of addressing using special jumpers, the "BlueBUS" system enables the user to make the control unit recognise the photocells and assign them with a correct detection function. The addressing operation must be done both on TX and RX (setting the jumpers in the same way) making sure there are no other couples of photocells with the same address.

In an automation for sliding gates, with ROBUS it is possible to install the photocells as shown in Figure 24.

Each time a photocell is added or removed the control unit must go through the recognition process; see paragraph 7.3.6 "Recognition of Other Devices".

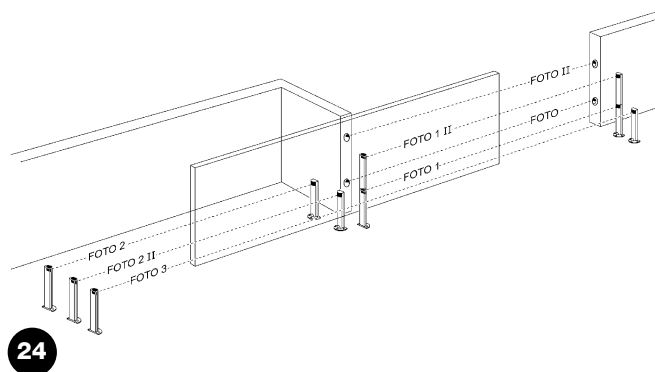

24

Tabelle 13: Photocell addressing

| Photocell | Jumpers | Photocell | Jumpers |
|--|---------|---|---------|
| FOTO External photocell h = 50 activated when gate closes | | FOTO 2 External photocell activated when gate opens | |
| FOTO II External photocell h = 100 activated when gate closes | | FOTO 2 II Internal photocell when gate opens | |
| FOTO 1 External photocell h = 50 activated when gate closes | | FOTO 3 Single photocell for the entire automation system | |
| FOTO 1 II Internal photocell h = 100 activated when gate closes | | ⚠ in the case of the installation of FOTO 3 and FOTO II together the position of the photocell elements (TX-RX) must comply with the provisions contained in the photocell instruction manual. | |

7.3.4) FT210B Photo-sensor

The FT210B photo-sensor unites in a single device a force limiting device (type C in accordance with the EN1245 standard) and a presence detector which detects the presence of obstacles on an optical axis between the TX transmitter and the RX receiver (type D in accordance with the EN12453 standard). The sensitive edge status signals on the FT210 photo-sensor are transmitted by means of the photocell beam, integrating the two systems in a single device. The transmitting part is positioned on the mobile leaf and is powered by a battery thereby eliminating unsightly connection systems; the consumption of the battery is reduced by special circuits guaranteeing a duration of up to 15 years (see the estimation details in the product instructions).

By combining a FT210B device to a sensitive edge (TCB65 for example) the level of security of the "main edge", required by the EN12453 standard for all "types of use" and "types of activation", can be attained. The FT210B is safe against individual faults when combined to a "resistive" type (8,2Kohm) sensitive edge. It features a special anticollision circuit that prevents interference with other detectors, even if not synchronised, and allows additional photocells to be fitted; for example, in cases where there is a passage of heavy vehicles and a second photocell is normally placed at 1 m from the ground.

See the FT210B instructions manual for further information concerning connection and addressing methods.

7.3.5 ROBUS in "Slave" mode

Properly programming and connecting, ROBUS can function in "Slave" mode; this type of function is used when 2 opposite gates need to be automated with the synchronised movement of the two leaves. In this mode ROBUS works as Master commanding the movement, while the second ROBUS acts as Slave, following the commands transmitted by the Master (all ROBUS are Masters when leaving the factory).

To configure ROBUS as a Slave the level one "Slave mode" must be activated (see table 7).

The connection between ROBUS Master and ROBUS Slave is made via BlueBus.

⚠ In this case the polarity of the connections between the two ROBUS must be respected as illustrated in fig. 26 (the other devices remain with no polarity).

Follow the operations below to install 2 ROBUS in the Master and Slave mode:

- Install the 2 motors as indicated in fig. 25. It is not important which motor is to function as Slave or Master; when choosing, one must consider the convenience of the connections and the fact that the Step-by-Step command of the Slave only allows the Slave leaf to be opened fully.

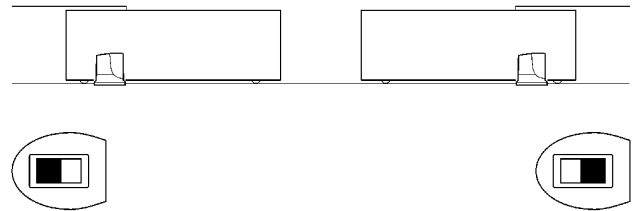

25

- Connect the 2 motors as shown in fig. 26.
- Select the opening direction of the 2 motors as shown in fig. 25 (see also paragraph "4.1 Choosing the direction").
- Supply power to the 2 motors.
- Program the "Slave mode" on the ROBUS Slave (see table 7).
- Perform the device recognition on the ROBUS Slave (see paragraph "4.3 Recognition of the devices").
- Perform the device recognition on the ROBUS Master (see paragraph "4.3 Recognition of the devices").
- Perform the recognition of the leaf length on the ROBUS Master (see paragraph "4.4 Recognition length of the leaf").

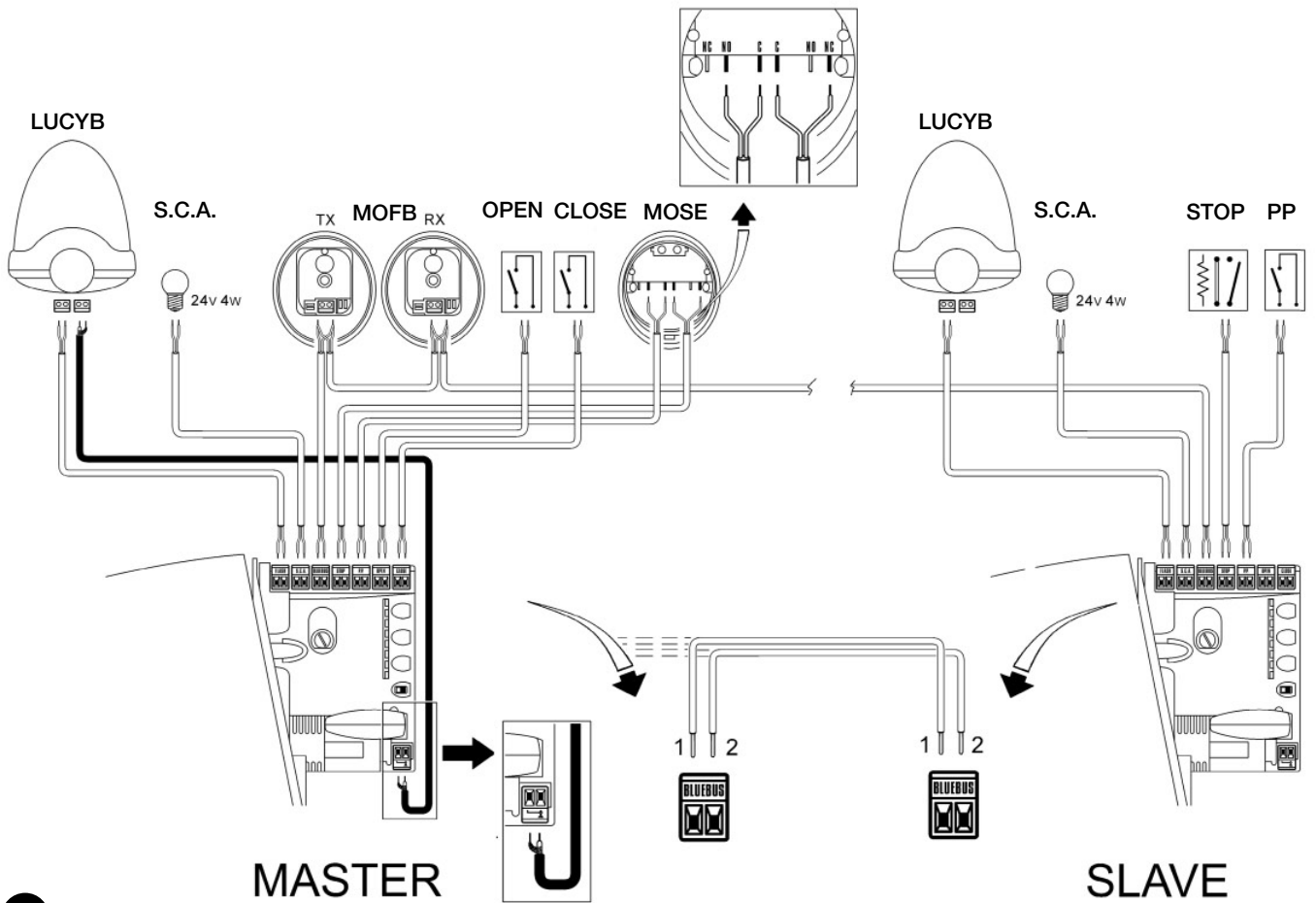

26

When connecting 2 ROBUS in the Master-Slave mode, pay attention that:

- All devices must be connected to the ROBUS Master (as in fig. 26) including the radio receiver.
- When using buffer batteries, each motor must have its own battery.
- All programming performed on ROBUS Slave are ignored (those on ROBUS Master override the others) except for those mentioned in table 14.

Tabella 14: ROBUS Slave programming independent from ROBUS Master

| Level one functions (ON-OFF functions) | Level two functions (adjustable parameters) |
|--|---|
| Stand-by | Motor speed |
| Peak | Open Gate Indicator Output |
| Slave Mode | Motor force |
| | Error list |

On Slave it is possible to connect:

- A flashing light (Flash)
- An open gate light (S.C.A.)
- A sensitive edge (Stop)
- A command device (Step by Step) that controls the complete opening of the Slave leaf only.
- The Open and Close inputs are not used on the Slave

7.3.6) Recognition of Other Devices

Normally the recognition of the devices connected to the BlueBUS and the STOP input takes place during the installation stage. However, if new devices are added or old ones removed, the recognition process can be gone through again by proceeding as shown in Figure 15.

Tabella 15: Recognition of Other Devices

| | Example |
|---|---------|
| 1. Press keys [▲] and [Set] and hold them down | |
| 2. Release the keys when L1 and L2 LED's start flashing very quickly (after approx. 3 s) | |
| 3. Wait a few seconds for the control unit to finish recognizing the devices | |
| 4. When the recognition stage is completed L1 and L2 LED's will go off, the STOP LED must remain on, while L1...L8 LED's will light up according to the status of the relative ON-OFF functions | |

⚠ After you have added or removed any devices, the automation system must be tested again according to the directions contained in paragraph 5.1 "Testing".

7.4) Special functions

7.4.1) "Always open" Function

The "Always open" function is a control unit feature which enables the user to control an opening manoeuvre when the "Step-by-Step" command lasts longer than 2 seconds. This is useful for connecting a timer contact to the "Step-by-Step" terminal in order to keep the gate open for

a certain length of time, for example. This feature is valid with any kind of "Step-by-Step" input programming, except for "Close". Please refer to the "Step-by-Step Function" parameter in Table 9.

7.4.2) Move anyway" function

In the event that one of the safety devices is not functioning properly or is out of use, it is still possible to command and move the gate in "Man present" mode.

Please refer to the Paragraph "Control with safety devices out of order" in the enclosure "Instructions and Warnings for users of the ROBUS gearmotor" for further information.

7.4.3) Maintenance warning

With ROBUS the user is warned when the automation requires a maintenance control. The number of manoeuvres after the warning can be selected from 8 levels, by means of the "Maintenance warning" adjustable parameter (see table 9).

Adjustment level 1 is "automatic" and takes into consideration the severity of the manoeuvre, this being the force and duration of the manoeuvre, while the other adjustments are established based on the number of manoeuvres.







The maintenance request signal is given by means of the flashing light (Flash) or by the light connected to the S.C.A. output when programmed as a "Maintenance light" (see table 9). The flashing light "Flash" and the maintenance light give the signals indicated in table 16, based on the number of manoeuvres performed in respect to the limits that have been programmed.

Tabella 16: maintenance warning with Flash and maintenance light

| Number of manoeuvres | Flash signal | Maintenance light signal |
|----------------------------------|--|----------------------------------|
| Lower than 80% of the limit | Normal (0.5s on, 0.5s off) | On for 2s when opening begins |
| Between 81 and 100% of the limit | Remains on for 2s at the beginning of the manoeuvre then carries on normally | Flashes throughout the manoeuvre |
| Over 100% of the limit | Remains ON for 2s at the start and end of the manoeuvre then carries on normally | Always flashes . |



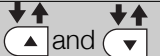
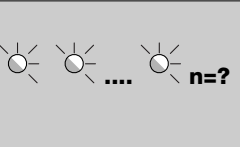



Control of the number of manoeuvres performed

The number of manoeuvres performed as a percentage on the set limit can be verified by means of the "Maintenance warning" function. Follow the indications in table 17 for this control.

| Tabella 17: control of the number of manoeuvres performed | Example |
|---|---|
| 1. Press the key [Set] and hold it down (approx. 3 s) |  |
| 2. Release the [Set] key when L1 LED starts flashing |  |
| 3. Press key [▲] or [▼] to move the flashing LED onto the input LED L7 representing the "Maintenance warning" parameter |  |
| 4. Press the key [Set] , and hold it down during step 5, 6 and 7 |  |
| 5. Wait approx. 3 seconds, after which the LED representing the current level of the parameter "Maintenance warning" will light up |  |
| 6. Press and immediately release the [▲] and [▼] keys. |  |
| 7. The LED that corresponds to the selected level flashes. The number of flashes indicates the percentage of manoeuvres performed (in multiples of 10%) in relation to the set limit. For example: with the maintenance warning set on L6 being 10000, 10% is equal to 1000 manoeuvres; if the LED flashes 4 times, this means that 40% of the manoeuvres have been reached (being between 4000 and 4999 manoeuvres). The LED will not flash if 10% of the manoeuvres hasn't been reached. |  |
| 8. Release the key [Set] |  |

Manoeuvre counter reset

After the maintenance of the system has been performed the manoeuvre counter must be reset. Proceed as described in table 18.

| Table 18: manoeuvre counter reset | Example |
|---|---|
| 1. Press the key [Set] and hold it down (approx. 3 s) |  |
| 2. Release the [Set] key when L1 LED starts flashing |  |
| 3. Press key [▲] or [▼] to move the flashing LED onto the input LED L7 representing the "Maintenance warning" parameter |  |
| 4. Press the key [Set] , and hold it down during step 5 and 6 |  |
| 5. Wait approx. 3 seconds, after which the LED representing the current level of the parameter "Maintenance warning" will light up. |  |
| 6. Press keys [▲] and [▼] , hold them down for at least 5 seconds and then release them. The LED that corresponds to the selected level flashes rapidly indicating that the manoeuvre counter has been reset |  |
| 7. Release the key [Set] |  |

7.5 Connection of Other Devices

If the user needs to feed external devices such as a proximity reader for transponder cards or the illumination light of the key-operated selector switch, it is possible to tap power as shown in Figure 27. The power supply voltage is 24Vdc -30% - +50% with a maximum available current of 100mA.

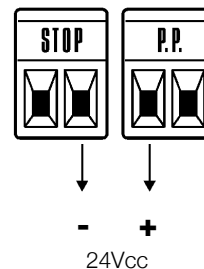

7.6) Troubleshooting

The table 19 contains instructions to help you solve malfunctions or errors that may occur during the installation stage or in case of failure.

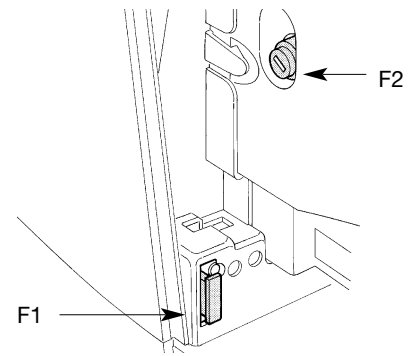

29













Tabella 19: Troubleshooting

| Symptoms | Recommended checks |
|--|---|
| The radio transmitter does not control the gate and the LED on the transmitter does not light up | Check to see if the transmitter batteries are exhausted, if necessary replace them |
| The radio transmitter does not control the gate but the LED on the transmitter lights up | Check to see if the transmitter has been memorised correctly in the radio receiver |
| No manoeuvre starts and the "BlueBUS" LED does not flash | Check that ROBUS is powered by a 230V mains supply. Check to see if the fuses are blown; if necessary, identify the reason for the failure and then replace the fuses with others having the same current rating and characteristics. |
| No manoeuvre starts and the flashing light is off | Make sure that the command is actually received. If the command reaches the STEP-BY-STEP input, the corresponding "STEP-BY-STEP" LED must light up; if you are using the radio transmitter, the "BlueBus" LED must make two quick flashes. |
| No manoeuvre starts and the flashing light flashes a few times | Count the flashes and check the corresponding value in table 21 |
| The manoeuvre starts but it is immediately followed by a reverse run | The selected force could be too low for this type of gate. Check to see whether there are any obstacles; if necessary increase the force |
| The manoeuvre is carried out but the flashing light does not work | Make sure that there is voltage on the flashing light's FLASH terminal during the manoeuvre (being intermittent, the voltage value is not important: approximately 10-30Vdc); if there is voltage, the problem is due to the lamp; in this case replace the lamp with one having the same characteristics; if there is no voltage, there may have been an overload on the FLASH output. Check that the cable has not short-circuited. |
| The manoeuvre is carried out but the Open Gate Indicator does not work | Check the type of function programmed for the S.C.A. output (Table 9) When the light should be on, check there is voltage on the S.C.A. terminal (approximately 24Vdc). If there is voltage, then the problem will have been caused by the light, which will have to be replaced with one with the same characteristics. If there is no voltage, there may have been an overload on the S.C.A. output. Check that the cable has not short-circuited. |

7.6.1) Malfunctions archive

ROBUS allows the possible malfunctions that have occurred in the last 8 manoeuvres to be viewed; for example, the interruption of a manoeuvre due to a photocell or sensitive edge cutting in. To verify the malfunctions list, proceed as in table 20.

Table 20: malfunctions archive

| | Example |
|--|---|
| 1. Press the key [Set] (approx. 3 s) |  3s |
| 2. Release the [Set] key when L1 LED starts flashing |  L1  |
| 3. Press key [▲] or [▼] to move the flashing LED onto the input LED L8 representing the "malfunctions list" parameter |   or   L8 |
| 4. Press the key [Set] , and hold it down during step 5 and 6 |  |
| 5. Wait for about 3s after which the LEDs corresponding to the manoeuvres in which the defect occurred will light. The L1 LED indicates the result of the last manoeuvre and L8 indicates the result of the 8th manoeuvre. If the LED is on, this means that a defect occurred during that manoeuvre; if the LED is off, this means that no defect occurred during that manoeuvre. | 3s  |
| 6. Press keys [▲] and [▼] to select the required manoeuvre: The corresponding LED flashes the same number of times as those made by the flashing light after a defect (see table 21). |   and  |
| 7. Release the key [Set] |  |

7.7) Diagnostics and signals

A few devices issue special signals that allow you to recognize the operating status or possible malfunctions.

7.7.1) Flashing light signalling

During the manoeuvre the flashing light FLASH flashes once every second. When something is wrong the flashes are more frequent; the light flashes twice with a second's pause between flashes.

| Tabella N°21: FLASH flashing light signalling | | |
|---|---|--|
| Quick flashes | Cause | ACTION |
| 1 flash 1 second's pause 1 flash | BlueBUS error | At the starting of the manoeuvre, the devices connected to BLUEBUS do not correspond to those recognized during the recognition phase. One or more devices may be faulty; check and, if necessary, replace them; in case of modifications repeat the recognition process (7.3.4 Recognition of Other Devices). |
| 2 flashes 1 second's pause 2 flashes | Triggering of a photocell | At the starting of the manoeuvre, one or more photocells do not enable it; check to see if there are any obstacles. This is normal when there is an obstacle impeding the movement. |
| 3 flashes 1 second's pause 3 flashes | Activation of the "motor force" limiting device | During the movement, the gate experienced excessive friction; identify the cause. |
| 4 flashes 1 second's pause 4 flashes | Activation of the STOP input | At the starting of the manoeuvre or during the movement, the STOP input was activated; identify the cause |
| 5 flashes 1 second's pause 5 lampeggi | Error in the internal parameters of the electronic control unit | Wait at least 30 seconds, then try giving a command. if the condition persists it means there is a malfunction and the electronic board has to be replaced |
| 6 flashes 1 second's pause 6 flashes | The maximum manoeuvre limit/hour has been exceeded. | Wait for a few minutes until the manoeuvre limiting device drops to under the maximum limit |
| 7 flashes 1 second's pause 7 flashes | here is an error in the internal electric circuits | Disconnect all the power circuits for a few seconds and then try to give the command again. if the condition persists it means there is a serious malfunction and the electronic board has to be replaced |
| 8 flashes 1 second's pause 8 flashes | A command that does not permit other commands to be performed is already present. | Check the type of command that is always present; for example, it could be a command from a timer on the "open" input. |

7.7.2) Signals on the control unit

On the ROBUS350 control unit there is a set of LED's each of which can give special indications both during normal operation and in case of malfunctions.

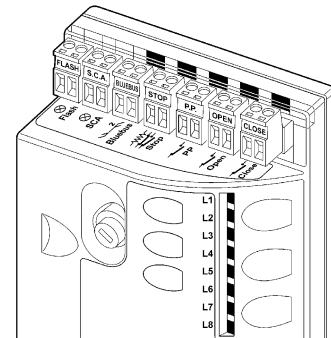

29

Tabella 22: LED's on the control unit's terminals

| BLUEBUS LED | Cause | ACTION |
|---|--------------------------------------|---|
| Off ACTION | Malfunction | Make sure there is power supply; check to see if the fuses are blown; if necessary, identify the reason for the failure and then replace the fuses with others having the same characteristics replaced |
| On | Serious malfunction | There is a serious malfunction; try switching off the control unit for a few seconds; if the condition persists it means there is a malfunction and the electronic board has to be replaced |
| One flash every second | Everything OK | Normal operation of control unit |
| 2 quick flashes | The status of the inputs has changed | This is normal when there is a change in one of the inputs: STEP-BY-STEP, STOP, OPEN, CLOSE, triggering of photocells or the radio transmitter is used |
| Series of flashes separated by a second's pause | Miscellaneous | It corresponds to the flashing light's signal. See table n° 21. |
| STOP LED | Cause | ACTION |
| Off ACTION | Activation of the STOP input | Check the devices connected to the STOP input |
| On | Everything OK | STOP Input active |
| STEP-BY-STEP LED | Cause | ACTION |
| Off | Everything OK | input not active |
| On | Activation of the STEP-BY-STEP input | This is normal if the device connected to the STEP-BY-STEP input is actually active |
| OPEN LED | Cause | ACTION |
| Off | Everything OK | OPEN input not active |
| On | Activation of the OPEN input | This is normal if the device connected to the OPEN input is actually active |
| CLOSE LED | Cause | ACTION |
| Off | Everything OK | CLOSE input not active |
| On | Activation of the CLOSE input | This is normal if the device connected to the CLOSE input is actually active |

Tabella 23: LED's on the control unit's keys

| Led 1 | Description |
|------------|---|
| Off | During normal operation the device indicates "Automatic Closing" is not active |
| on | During normal operation the device indicates "Automatic Closing" is active. |
| It flashes | <ul style="list-style-type: none"> Function programming in progress. If it flashes together with L2, it means that the user must carry out the device recognition phase (refer to Paragraph "4.3 Recognition of the devices"). |
| Led L2 | Description |
| Off | During normal operation the device indicates "Close after photo" is not active. |
| on | During normal operation the device indicates "Close after photo" is active. |
| It flashes | <ul style="list-style-type: none"> Function programming in progress. If it flashes together with L1, it means that the user must carry out the device recognition phase (refer to Paragraph "4.3 Recognition of the devices"). |
| Led L3 | Description |
| Off | During normal operation the device indicates "Always close" is not active. |
| on | During normal operation the device indicates "Always close" is active. |
| It flashes | <ul style="list-style-type: none"> Function programming in progress. If it flashes together with L4, it means that the user must carry out the leaf length recognition phase (refer to Paragraph "4.4 Recognition length of the leaf"). |
| Led L4 | Description |
| Off | During normal operation the device indicates "Stand-by" is not active. |
| on | During normal operation the device indicates "Stand-by" is active. |
| It flashes | <ul style="list-style-type: none"> Function programming in progress. If it flashes together with L3, it means that the user must carry out the leaf length recognition phase (refer to Paragraph "4.4 Recognition length of the leaf"). |
| Led L5 | Description |
| Off | During normal operation the device indicates "Thrust" is not active. |
| on | During normal operation the device indicates "Thrust" is active. |
| It flashes | Function programming in progress. |
| Led L6 | Description |
| Off | During normal operation the device indicates "Pre-flashing" is not active. |
| on | During normal operation the device indicates "Pre-flashing" is active. |
| It flashes | Function programming in progress. |
| Led L7 | Description |
| Off | During normal operation the device indicates that the CLOSE input activates a closing manoeuvre. |
| on | During normal operation the device indicates that the CLOSE input activates a partial opening manoeuvre. |
| It flashes | Function programming in progress. |
| Led L8 | Description |
| Off | During normal operation the device indicates that ROBUS is configured as Master. |
| on | During normal operation the device indicates that ROBUS is configured as Slave. |
| It flashes | Function programming in progress. |

7.8) Accessories

The following optional accessories are available for ROBUS:

- PS124 PS124 24 V Buffer battery - 1,2Ah with integrated charger battery.
- SMXI or SMXIS 433.92MHz Radio receiver with digital Rolling code.

For information on the complete range of accessories, refer to the Nice s.p.a. product catalogue.

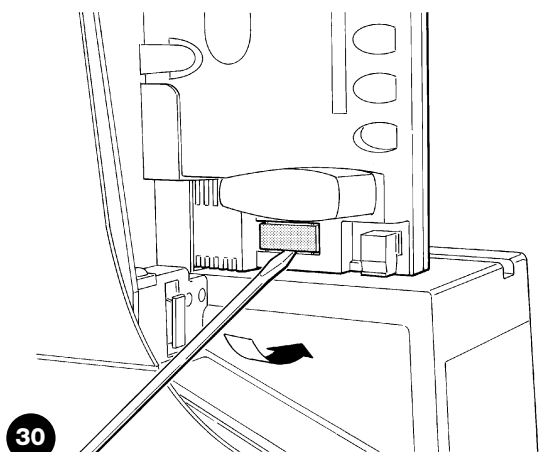

30

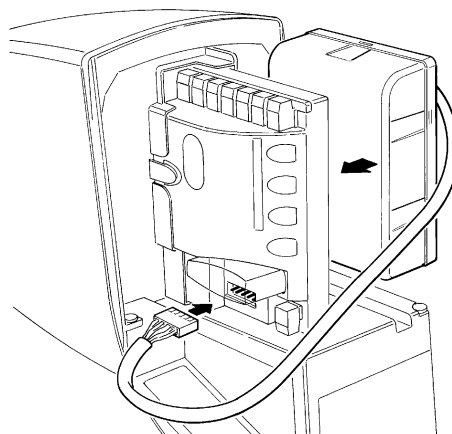

31

Congratulations for having chosen a Nice product for your automation system! Nice S.p.A. produces components for the automation of gates, doors, rolling gates, roller shutters and awnings: gearmotors, control units, radio controls, flashing lights, photocells and miscellaneous accessories. Nice uses only the finest materials and first-class workmanship. It focuses on the development of innovative solutions designed to simplify the use of its equipment, dedicating meticulous care to the study of its technical, aesthetic and ergonomic characteristics: From the wide range of Nice products, your installation technician will certainly have selected the one best suited to your specific requirements. However, Nice is not the producer of your automation system, which is rather the result of a combination of operations carried out by your installation technician, namely analysis, evaluation, selection of materials and system implementation. Each automation system is unique. Your installation technician is the only person who possesses the experience and professionalism needed to set up a system capable of satisfying your requirements, a system that is safe, reliable, long lasting and built in accordance with the regulations in force. An automation system is not only very convenient; it also improves the level of security in your home. Moreover, it will last for years with very little maintenance. Even though the automation system you possess meets the safety requirements of the legislation in force, this does not exclude the existence of a "residual risk", i.e. the possibility that dangers may arise, usually as a result of improper or unreasonable use. We have prepared the following list of do's and don'ts to help you avoid any mishaps:

- **Before using your automation system for the first time**, ask the installer to explain the origin of residual risks; take a few minutes and read the users **instructions manual given you by the installer**. Retain the manual for future use and deliver it to any subsequent owner of the automation system.

- **Your automation system is a machine that will faithfully execute your commands**; unreasonable or improper use may generate dangers: do not operate the system if there are people, animals or objects within its range of operation.

- **Children**: automation systems are designed to guarantee high levels of safety and security. They are equipped with detection devices that prevent movement if people or objects are in the way, guaranteeing safe and reliable activation. However, children should not be allowed to play in the vicinity of automated systems; to prevent any accidental activations, keep all remote controls away from children: **they are not toys!**

- **Malfunctions**: If you notice that your automation is not functioning properly, disconnect the power supply

to the system and operate the manual release device. Do not attempt to make any repairs; call the installation technician and in the meantime, operate the system like a non-automatic door after releasing the gearmotor as described below.

- **Maintenance**: Like any machine, your automation needs regular periodic maintenance to ensure its long life and total safety. Arrange a periodic maintenance schedule with your installation technician. Nice recommends that maintenance checks be carried out every six months for normal domestic use, but this interval may vary depending on the intensity of use. Only qualified personnel are authorised to carry out checks, maintenance operations and repairs.

- Do not modify the system or its programming and adjustment parameters in any way, even if you feel capable of doing it: your installation technician is responsible for the system.

- The final test, the periodic maintenance operations and any repairs must be documented by the person who has performed them; these documents must remain under the custody of the owner of the system.

The only recommended maintenance operations that the user can perform periodically concern the cleaning of the photocell glasses and the removal of **leaves and debris that may impede the automation**. To prevent anyone from activating the gate release the automation system (as described below). Use a slightly damp cloth to clean.

- **Disposal**: At the end of its useful life, the automation must be dismantled by qualified personnel, and the materials must be recycled or disposed of in compliance with the legislation locally in force.

- **In the event of malfunctions or power failures**. While you are waiting for the technician to come (or for the power to be restored if your system is not equipped with buffer batteries), you can operate the system like any non-automatic gate. In order to do this you need to manually release the gearmotor (this operation is the only one that the user of the automation is authorized to perform): This operation has been carefully designed by Nice to make it extremely easy, without any need for tools or physical exertion.

Manual movement and release: before carrying out this operation please note that release can only occur when the leaf is stopped.

1 Slide the lock cover disc

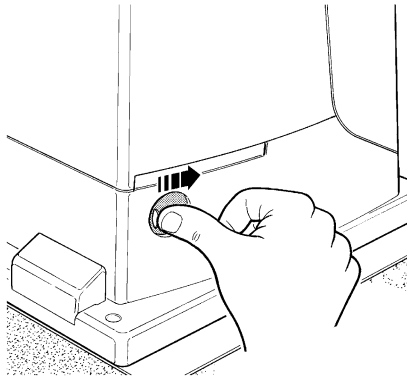

2 Insert and turn the key clockwise.

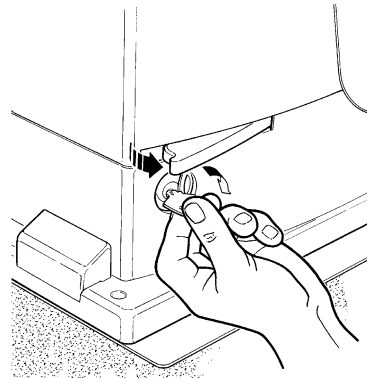

3 Pull the release handle

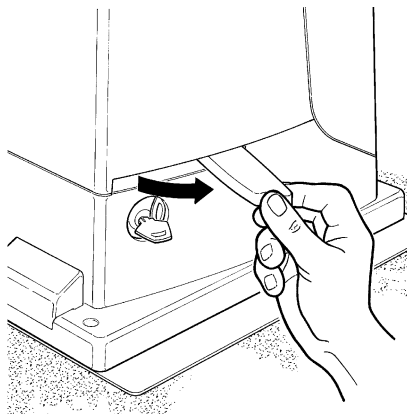

4 Move the leaf manually.

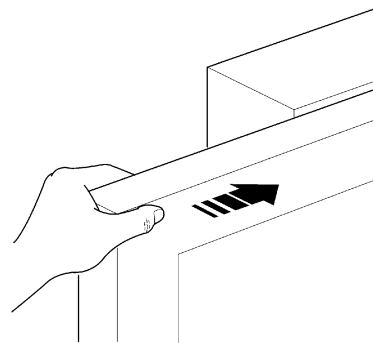

To lock: carry out the same procedures backwards.

Control with safety devices out of order: If the safety devices are malfunctioning, it is still possible to control the gate.

- Operate the gate control device (remote control or key-operated selector switch, etc.). If the safety devices enable the operation, the gate will open and close normally, otherwise the flashing light flashes a few times but the manoeuvre does not start (the number of flashes depends on the reason why the manoeuvre is not enabled).
- In this case, **actuate the control** again within 3 seconds and keep it actuated.
- After approximately 2s the gate will start moving in the "man present" mode, i.e. so long as the control is maintained the gate will keep moving; as soon as the control is released the gate will stop.

⚠ If the safety devices are out of order the automation must be repaired as soon as possible.

Replacing the Remote Control Battery: if your radio control, after a period of time, seems not to work as well, or not to work at all, it may simply be that the battery is exhausted (depending on the type of use, it may last from several months up to one year and more). In this case you will see that the light confirming the transmission is weak, or does not come on, or comes on only briefly. Before calling the installation technician try exchanging the battery with one from another operating transmitter:

if the problem is caused by a low battery, just replace it with another of the same type. The batteries contain polluting substances: do not dispose of them together with other waste but use the methods established by local regulations.

Are you satisfied? If you wish to install another automation system in your home, call your old installation technician and use Nice products. You will get the services of a specialist and the most advanced products available on the market, superior performances and maximum system compatibility. Thank you for reading these instructions. We feel confident that you will be well satisfied with your new system: for any present or future requirements, please contact your reliable installation technician.

Declaration of conformity

Declaration of Conformity

Dichiarazione CE di conformità secondo Direttiva 98/37/CE, Allegato II, parte B (dichiarazione CE di conformità del fabbricante)
CE Declaration of Conformity according to Directive 98/37/EC, Annex II, part B

Numero 210/ROBUS Revisione: 0
Number Revision

Il sottoscritto Lauro Buoro in qualità di Amministratore Delegato, dichiara sotto la propria responsabilità che il prodotto:
The undersigned Lauro Buoro, managing director, declares under his sole responsibility that the following product:

Nome produttore: NICE s.p.a.
Manufacturer's name

Indirizzo Via Pezza Alta 13, 31046 Z.I. Rustignè, Oderzo (TV) Italia
Address

Tipo Motoriduttore elettromeccanico con centrale incorporata
Type electromechanical gearmotor with incorporated control unit

Modello RB600, RB600P, RB1000, RB1000P
Models

Accessori: Ricevente radio SMXI, SMXIS; batteria di emergenza PS124
Accessories SMXI radio receiver; PS124 emergency battery

Risulta conforme a quanto previsto dalla direttiva comunitaria:
Satisfies the essential requirements of the following Directives

98/37/CE (89/392/CEE modificata) DIRETTIVA 98/37/CE DEL PARLAMENTO EUROPEO E DEL CONSIGLIO del 22 giugno 1998 concernente il ravvicinamento delle legislazioni degli Stati membri relative alle macchine.
98/37/CE (ex 89/392/EEC) DIRECTIVE 98/37/EC OF THE EUROPEAN PARLIAMENT AND OF THE COUNCIL of June 22, 1998, for the harmonisation of the legislations of member States regarding machines.

Come previsto dalla direttiva 98/37/CE si avverte che non è consentita la messa in servizio del prodotto sopra indicato finché la macchina, in cui il prodotto è incorporato, non sia stata identificata e dichiarata conforme alla direttiva 98/37/CE.
As specified in the 98/37/EC directive, the use of the product specified above is not admitted until the machine in which it is incorporated has been identified and declared as conforming to the 98/37/EC directive.

Inoltre il prodotto risulta conforme a quanto previsto dalle seguenti direttive comunitarie, così come modificate dalla Direttiva 93/68/CEE del consiglio del 22 Luglio 1993:
Furthermore, the product complies with the specifications of the following EC directives, as amended by the directive 93/68/EEC of the European Council of 22 July 1993:

73/23/CEE DIRETTIVA 73/23/CEE DEL CONSIGLIO del 19 febbraio 1973 concernente il riavvicinamento delle legislazioni degli Stati membri relative al materiale elettrico destinato ad essere adoperato entro taluni limiti di tensione.
73/23/EEC DIRECTIVE 73/23/EEC OF THE COUNCIL of February 19, 1973 for the harmonisation of the legislations of member States regarding electrical equipment designed to be used within certain voltage limits.

Secondo le seguenti norme armonizzate: EN 60335-1; EN 60335-2-103.
In compliance with the following harmonised standards: EN 60335-1; EN 60335-2-103.

89/336/CEE DIRETTIVA 89/336/CEE DEL CONSIGLIO del 3 maggio 1989, per il riavvicinamento delle legislazioni degli Stati membri relative alla compatibilità elettromagnetica.
89/336/EEC DIRECTIVE 89/336/EEC OF THE COUNCIL of May 3, 1989, for the harmonisation of the legislations of member States regarding electromagnetic compatibility.

Secondo le seguenti norme armonizzate: EN 61000-6-2; EN 61000-6-3
In compliance with the following harmonised standards: EN 61000-6-2; EN 61000-6-3

Oderzo, 2 dicembre 2004
Oderzo, 2 december 2004

Amministratore Delegato
Managing Director
Lauro Buoro



COMPANY
WITH QUALITY SYSTEM
CERTIFIED BY DNV
=ISO 9001/2000=

 **Nice SpA**
Oderzo TV Italia
Tel. +39.0422.85.38.38
Fax +39.0422.85.35.85
info@niceforyou.com

 **Nice Padova**
Sarmeola di Rubano PD Italia
Tel. +39.049.89.78.93.2
Fax +39.049.89.73.85.2
infopd@niceforyou.com

 **Nice Roma**
Roma Italia
Tel. +39.06.72.67.17.61
Fax +39.06.72.67.55.20
inforoma@niceforyou.com

 **Nice France**
Buchelay
Tel. +33.(0)1.30.33.95.95
Fax +33.(0)1.30.33.95.96

 **Nice Rhône-Alpes**
Decines Charpieu France
Tel. +33.(0)4.78.26.56.53
Fax +33.(0)4.78.26.57.53

 **Nice France Sud**
Aubagne France
Tel. +33.(0)4.42.62.42.52
Fax +33.(0)4.42.62.42.50

 **Nice Belgium**
Leuven (Heverlee)
Tel. +32.(0)16.38.69.00
Fax +32.(0)16.38.69.01
info@be.niceforyou.com

 **Nice España Madrid**
Tel. +34.9.16.16.33.00
Fax +34.9.16.16.30.10
info@es.niceforyou.com

 **Nice España Barcelona**
Tel. +34.9.35.88.34.32
Fax +34.9.35.88.42.49
info@es.niceforyou.com

 **Nice Polska**
Pruszków
Tel. +48.22.728.33.22
Fax +48.22.728.25.10
info@pl.niceforyou.com

 **Nice UK**
Chesterfield
Tel. +44.87.07.55.30.10
Fax +44.87.07.55.30.11
info@uk.niceforyou.com

 **Nice China**
Shanghai
Tel. +86.21.575.701.45/46
Fax +86.21.575.701.44
info@cn.niceforyou.com