

Wingo

Swing gate opener

4024 Kit

5024 Kit

4000 Kit

5000 Kit

CE

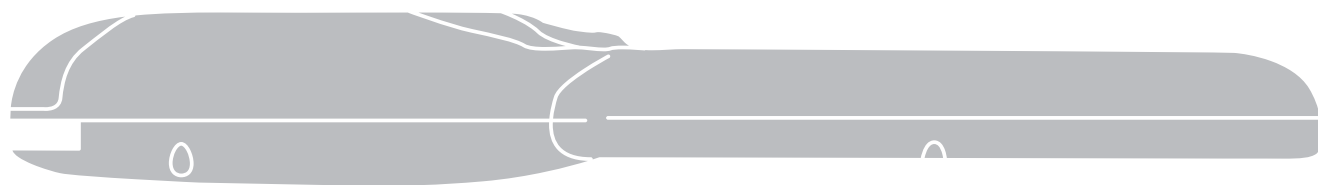

EN - Instructions and warnings for installation and use

Nice

EN - Addendum to manual Wingo**IT - Addendum al manuale Wingo****FR - Addendum au manuel Wingo****ES - Addendum al manual Wingo****DE - Nachtrag zur Anleitung Wingo****PL - Załącznik do instrukcji Wingo****NL - Addendum bij de handleiding Wingo**

Nice

EN - For more information on the use of the products **Wingo WG2024** and **Wingo WG3524** refer to the instruction manual "Wingo WG4024-WG5024-WG4000 -WG5000".

Wingo WG2024: refer to data of model WG4024;

Wingo WG3524: refer to data of model WG5024.

IT - Per l'impiego dei prodotti **Wingo WG2024** e **Wingo WG3524** fare riferimento al manuale istruzioni "Wingo WG4024-WG5024-WG4000 -WG5000".

Wingo WG2024: fare riferimento ai dati del modello WG4024;

Wingo WG3524: fare riferimento ai dati del modello WG5024.

FR - Pour l'utilisation des produits **Wingo WG2024** et **Wingo WG3524** se référer au guide d'instructions « Wingo WG4024-WG5024-WG4000 -WG5000 ».

Wingo WG2024 : se référer aux données du modèle WG4024 ;

Wingo WG3524 : se référer aux données du modèle WG5024.

ES - Para utilizar los productos **Wingo WG2024** y **Wingo WG3524** consulte el manual de instrucciones "Wingo WG4024-WG5024-WG4000 -WG5000".

Wingo WG2024: consulte los datos del modelo WG4024;

Wingo WG3524: consulte los datos del modelo WG5024.

DE - Zur Anwendung der Produkte **Wingo WG2024** und **Wingo WG3524** beziehen Sie sich bitte auf die Gebrauchsanleitung "Wingo WG4024-WG5024-WG4000 -WG5000".

Wingo WG2024: Bezugnahme auf die Daten des Modells WG4024;

Wingo WG3524: Bezugnahme auf die Daten des Modells WG5024.

PL - Podczas stosowania urządzeń **Wingo WG2024** i **Wingo WG3524** należy odwołać się do instrukcji obsługi "Wingo WG4024-WG5024-WG4000 -WG5000".

Wingo WG2024: Odwołać się do danych modelu WG4024;

Wingo WG3524: Odwołać się do danych modelu WG5024.

NL - Voor informatie over het gebruik van de producten **Wingo WG2024** en **Wingo WG3524** gelieve u de handleiding "Wingo WG4024-WG5024-WG4000 -WG5000" te raadplegen.

Wingo WG2024: raadpleeg de gegevens van het model WG4024;

Wingo WG3524: raadpleeg de gegevens van het model WG5024.

DICHIARAZIONE CE DI CONFORMITÀ / CE DECLARATION OF CONFORMITY

Nota - Il contenuto di questa dichiarazione corrisponde a quanto dichiarato nell'ultima revisione disponibile, prima della stampa di questo manuale, del documento ufficiale depositato presso la sede di Nice Spa. Il presente testo è stato riadattato per motivi editoriali. / **Note** - The content of the present declaration corresponds to the latest available revision, before the printing of the present manual, of the document registered at the head offices of Nice S.p.a. The present text has been readapted for publishing reasons.

Numero / Number: 299/WG..24

Revisione / Revision: 0

Il sottoscritto Lauro Buoro in qualità di Amministratore Delegato, dichiara sotto la propria responsabilità che il prodotto / *The undersigned Lauro Buoro, managing director, declares under his sole responsibility that the following product:*

Nome produttore / Manufacturer's name: NICE s.p.a.
Indirizzo / Address: Via Pezza Alta 13, Z.I. Rustignè, 31046 Oderzo (TV) Italy
Tipo / Type: Motoriduttore elettromeccanico 24 Vd.c. / 24Vdc Electromechanical gearmotor
Modelli / Models: WG3524, WG2024
Accessori / Accessory:

Risulta conforme a quanto previsto dalle seguenti direttive comunitarie / *conforms with the requirements of the following EC directives:*

- 98/37/CE (89/392/CEE modificata) DIRETTIVA 98/37/CE DEL PARLAMENTO EUROPEO E DEL CONSIGLIO del 22 giugno 1998 concernente il ravvicinamento delle legislazioni degli Stati membri relative alle macchine / *98/37/EC (89/392/EEC amended); DIRECTIVE 98/37/EC OF THE EUROPEAN PARLIAMENT AND COUNCIL of 22 June 1998 regarding the approximation of member state legislation relating to machinery*

Come previsto dalla direttiva 98/37/CE si avverte che non è consentita la messa in servizio del prodotto sopra indicato finché la macchina, in cui il prodotto è incorporato, non sia stata identificata e dichiarata conforme alla direttiva 98/37/CE. / *As established in directive 98/37/EC, the above-mentioned product may not be started up unless the machine in which the product is incorporated has been identified and declared as conforming to directive 98/37/EC.*

Inoltre il prodotto risulta conforme a quanto previsto dalle seguenti direttive comunitarie, così come modificate dalla Direttiva 93/68/CEE del consiglio del 22 Luglio 1993 / *Satisfies the essential requirements of the following Directives, as amended by the directive 93/68/EEC of the European Council of 22nd July 1993:*

- 2006/95/CEE(ex direttiva 73/23/CE) DIRETTIVA 2006/95/CE DEL PARLAMENTO EUROPEO E DEL CONSIGLIO del 12 dicembre 2006 concernente il ravvicinamento delle legislazioni degli Stati membri relative al materiale elettrico destinato ad essere adoperato entro taluni limiti di tensione / *2006/95/EEC (ex directive 73/23/EEC); DIRECTIVE 2006/95/EEC OF THE EUROPEAN PARLIAMENT AND COUNCIL of 12 December 2006 regarding the approximation of member state legislation relating to electrical material intended for use within specific voltage limits*
Secondo le seguenti norme armonizzate / *According to the following harmonised standards:* EN 60335-1:1994+A11:1995+A11:1996+A12:1996 +A13:1998+A14:1998+A15:2000+A2:2000+A16:2001
- 2004/108/CEE(ex direttiva 89/336/CEE) DIRETTIVA 2004/108/CE DEL PARLAMENTO EUROPEO E DEL CONSIGLIO del 15 dicembre 2004 concernente il ravvicinamento delle legislazioni degli Stati membri relative alla compatibilità elettromagnetica e che abroga la direttiva 89/336/CEE / *2004/108/EEC (ex directive 89/336/EEC); DIRECTIVE 2004/108/EEC OF THE EUROPEAN PARLIAMENT AND COUNCIL of 15 December 2004 regarding the approximation of member state legislation relating to electromagnetic compatibility, repealing directive 89/336/EEC*
Secondo le seguenti norme armonizzate / *According to the following harmonised standards:* EN 61000-6-2:2005; EN 61000-6-3:2001+A11:2004

Inoltre risulta conforme; limitatamente per le parti applicabili, alle seguenti norme / *The product also complies with the applicable parts of the following standards:*

EN 60335-1:2002+A1:2004+A11:2004+A12:2006+ A2:2006, EN 60335-2-103:2003, EN 13241-1:2003; EN 12453:2002; EN 12445:2002; EN 12978:2003

Oderzo, 16 ottobre 2008 / *Oderzo, 16 October 2008*

Lauro Buoro
(Amministratore Delegato / *Managing Director*)

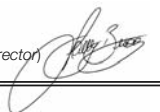

This product is intended to be used for automating swing gates or doors in an exclusively residential context. **CAUTION! – Any other use different to that described and in ambient conditions different to those set out in this manual is to be considered improper and forbidden!**

The product is an electromechanical gear motor, equipped with a 24 v continuous current or 230V (depending on the model) alternate current motor and an endless screw reduction gear.

The gear motor is powered by the external control unit to which it is connected. In the event of a black out, it is possible to move the gate leaves by hand, unblocking the gear motor manually.

Fig. 1 shows all the components provided in the package (according to the model chosen):

- [a] - electromechanical gear motor
- [b] - front bracket (for fixing the gear motor to the gate leaf)
- [c] - rear bracket and plate (for fixing the gear motor to the wall)
- [d] - metal parts (screws, washers, etc.)
- [e] - keys to manually unlock the gear motor

1 GENERAL SAFETY WARNINGS AND PRECAUTIONS

Safety warnings

- **CAUTION!** - This manual contains important instructions and warnings for personal safety. Wrong installation can cause serious injuries. Before starting work read all the manual carefully. If in doubt, stop installation and ask the Nice Assistance Department for clarifications.
- **CAUTION!** – According to the most recent European legislation, the realisation of an automatic door or gate must comply with the regulations of Directive 98/37/CE (Machine Directive) and in particular, standards EN 12445; EN 12543; EN 12635 and EN 13214-1, which declare the presumed conformity of the automation. **In consideration of this, all the installation, connection, inspection and maintenance operations of the product must be performed exclusively by a qualified and competent technician!**
- **CAUTION!** – Important instructions: keep this manual for any possible future requirement for maintenance and disposal of the product.

Warnings for installation

- Before installing check if this product is suited to automating your gate or door (see chapter 3 and “Technical features of the product”). If unsuitable, DO NOT proceed with the installation.
- Include a disconnection device in the power supply system with an opening distance between the contacts to permit full disconnection in the conditions dictated by the category of surcharge III.
- **All the installation and maintenance operations must occur with the automation disconnected from the electrical power supply.** If the disconnection device of the power supply is not visible from the area where the automatism is located, before starting the work it is necessary to attach a sign with the text “CAUTION! MAINTENANCE IN PROGRESS” on the disconnection device.
- During installation handle the automatism with care avoiding crushing, knocks, falls or contact with liquids of any kind. Do not place the product near sources of heat, or expose it to naked flames. All these activities can damage and cause malfunctions or dangerous situations. If this occurs, stop the installation immediately and contact the Nice Assistance Department.
- Do not make alterations to any part of the product. Operations which are not permitted will cause only malfunctions. The manufacturer declines any liability for damage caused by arbitrary alterations to the product.
- If the gate or the door to be automated is fitted with a pedestrian door it is necessary to include a control system in the installation to prevent the operation of the motor when the pedestrian door is open.
- Check there are no trapping points towards fixed parts when the leaf of the gate is in the maximum *Open* position, if necessary protect these parts.
- The push button control on the wall must be positioned in sight of the automation, away from the moving parts, at a minimum height of 1.5 m from the ground and it must not be accessible to the public.
- The product packaging material must be disposed of respecting the local regulations in force.

3 INSTALLATION

3.1 - Checks before installation

Before installation, check the integrity of the components, suitability of the model chosen and suitability of the environment chosen for the installation.

IMPORTANT – The gear motor cannot automate a manual gate which does not have a safe and efficient mechanical structure. Furthermore, it cannot solve the faults caused by wrong installation or bad maintenance of the gate itself.

3.2 - Suitability of the gate to being automated and the surrounding environment

- Check the mechanical structure of the gate is suited to being automated and conforms to the national laws in force (*if necessary make reference to the data on the gate label*).
- Moving the gate leaf manually in Open and Close position, check the movement occurs with equal and constant attrition at each point of the stroke (*there must be no moments of greater effort*).
- Check the gate leaf remains balanced, that it does not move if brought manually to any position and left stopped.
- Check the space around the gear motor allows to manually unblock the gate leaf, easily and safely.
- Check the surfaces chosen for installing the product are solid and can guarantee stable fixing.
- Check the fixing zone of the gear motor is compatible with the size of the latter, see **fig. 2**: the correct *Opening* movement of the gate and the force the motor exerts to perform it, depend on the position in which the rear fixing bracket is secured. Therefore, before installing it is necessary to make reference to **graph 2** to define the maximum *Opening* angle of the leaf and the force of the motor, suited to the individual system.

3.3 - Limits of use of the product

Before installing the product, check the gate leaf is the right size and weight and falls within the limits shown in **graph 1**.

3.4 - Preparing for installation

Fig. 3 shows an example of an automation system designed with Nice components. These components are positioned according to a typical and usual scheme.

Making reference to **fig. 3**, decide the approximate position in which to install each component envisaged by the system and the most appropriate connection diagram.

Useful components for producing a complete system (fig. 3):

- A - Electromechanical gear motors
- B - Couple of photocells
- C - Couple of stop blocks (in Opening)
- D - Columns for photocells
- E - Flashing signalling device with incorporated antenna
- F - Key selector switch or digital keypad
- G - Control unit

3.5 - Installation of fixing brackets and gear motor

3.5.1 - Installation of rear fixing bracket

Calculate the position of the rear bracket using **graph 2**.

This graph serves to establish **dimensions A** and **B** and the **value of the maximum opening angle** of the leaf. **Important – The values of A and B must be similar to allow linear movement of the automation.**

- 01.** Measure **dimension C** (fig. 4) on the fixing side;
- 02.** On **graph 2**, identify **dimension C** found and trace a horizontal line that determines the value of **dimension B (*)** as shown in the example of **fig. 5**; the meeting point with line "r.i.l" (installation line recommended) determines the value of the angle of maximum opening. From this point, trace a vertical line as shown in the example of **fig. 5** to determine the value of **dimension A**.
If the angle found does not correspond to the requirements, adapt dimension A and if necessary dimension B, so they are similar.
- 03.** Before being fixed to the wall the bracket must be sealed to the specific fixing plate (**fig. 6**); if necessary the bracket can be cut adapting values of dimensions A and B.
Note – The rear bracket provided with the gearmotor has a length of 150 mm; in the case of special applications or an outward opening gate (fig. 7) the bracket model PLA6 (optional accessory) may be used.
CAUTION! – Before securing the rear bracket, check the fixing zone of the front bracket is in a solid part of the leaf, as this bracket must be fixed at a different height of the rear bracket (fig. 8).
- 04.** At this point, fix the bracket using dowels, screws and washers required (not supplied).

3.5.2 – Installation of front fixing bracket

The front bracket must be fixed to the gate leaf respecting the values of **dimensions D** and **E** (Fig. 4).

Note – The front bracket provided with the gearmotor must be welded directly onto the gate leaf. If this is not possible, use the bracket model PLA8 (optional accessory)

- 01.** Establish the value of **dimension E** using **Table 1**;
- 02.** Establish the height in which to position the front bracket, referring to **fig. 8**;
- 03.** Fix the bracket to the solid part of the gate leaf.

TABLE 1

Model:	WG4024-WG4000-WG4000/V1	WG5024-WG5000-WG5000/V1
D (mm):	700	850
A (mm)	E (mm)	
100	600	750
110	590	740
120	580	730
130	570	720
140	560	710
150	550	700
160	540	690
170	530	680
180	520	670
190	510	660
200	500	650
210	490	640
220	480	630
230	470	620
240		610
250		600
260		590
270		580
280		570

3.5.3 – Installation of the gear motor on the fixing brackets

• Installing the gear motor on the rear bracket:

- 01.** Fix the gear motor to the bracket as shown in **fig. 9** using the screw, washer and nut supplied;
- 02.** Tighten the nut to the end and then loosen by 1/10 of a turn to allow minimum clearance between the parts.

• Installing the gear motor on the front bracket:

- 01.** Fix the gear motor to the bracket as shown in **fig. 10** using the screw, washer and nut supplied;
- 02.** Tighten the screw to the end.
- 03.** Fix the label provided in the package, dealing with the unblocking and blocking operations of the gear motor, permanently close to the gear motor

3.6 - Setting the mechanical limit switch

The mechanical limit switch allows to set the stop position of the gate leaf, in this way, it is not necessary to use the stop blocks and the leaf does not hit against these at the end of the manoeuvre.

WARNING – In the event of applications with a gate equipped with opening towards the outside (fig. 7) it is necessary to invert the power supply wires. Set the **limit switch in Opening** of the gear motor as follows:

- 01.** Unblock the gear motor as shown in **fig. 14**;
- 02.** Loosen the mechanical stop screw;
- 03.** Bring the gate leaf manually to the *Open* position required;
- 04.** Then, bring the mechanical stop to the end of the pin and block the screw (**fig. 11**).
- 05.** Bring the leaf manually to the *Close* position and block the gear motor.

4 ELECTRICAL CONNECTIONS

CAUTION!

- A wrong connection can cause faults or danger; therefore follow scrupulously the connections set out.
- Perform the connection operations when the electricity is off.

To connect the gear motor to the control unit, proceed as follows:

- 01.** Remove the lid of the gear motor as shown in **fig. 12**;
- 02.** Slacken the gearmotor cable clamp, thread the connecting cable through the hole and connect the three electric wires as shown in **fig. 13**;
- 03.** Replace lid on gear motor.

To check the connections, direction of rotation of the motor, phase shift in the movement of the leaves and setting the limit switch, refer to the instructions manual of the control unit.

IMPORTANT – With a gate configured with opening towards the outside invert the power supply wires with respect to the standard installation.

5 INSPECTING THE AUTOMATION

This is the most important phase in realising the automation to guarantee maximum safety. The inspection can be used also to periodically check the devices which make up the automatism.

The inspection of the entire system must be performed by expert and qualified staff who must take responsibility of the tests requested, depending on the risk involved and to check compliance of what is set out by laws, rules and regulations and in particular all the requirements of regulation EN 12445 which establishes the testing methods to verify gate automatisms.

Inspection

Each single component of the automatism, for example sensitive edges, photocells, emergency shutdowns, etc. requires a specific inspection phase; for these devices follow the procedures shown in the respective instruction manuals. For inspection of the gear motor follow the operations below:

- 01.** Check that everything in this manual and in particular in chapter 1 has been rigorously complied with;
- 02.** Unblock the gear motor as shown in **fig. 14**;
- 03.** Check it is possible to manually move the leaf when opening and closing with a force no greater than 390N (approx. 40 kg);
- 04.** Block the gear motor and connect the electrical power supply;
- 05.** Using the control or shutdown devices envisaged (key selector switch, control buttons or radio transmitters), perform a number of opening, closing and stopping tests of the gate and check it behaves as it should;
- 06.** Check the correct operation of all the safety devices one by one in the system (photocells, sensitive edges, emergency shutdown, etc.) and check the gate behaves as it should;
- 07.** Command a closing manoeuvre and check the force of the impact of the leaf against the end of the mechanical limit switch. If necessary, try to unload the pressure, finding a setting which gives better results;
- 08.** If the dangerous situations caused by the movement of the leaf have been protected by limiting the force of impact the force must be measured as required by regulation EN 12445;

Note – The gear motor is not provided with torque setting devices, such regulations are done by the Control unit.

Putting into operation

This can occur only after having performed, with positive results, all the inspection phases of the gear motor and other devices present. To put it into operation refer to the instructions manual of the control unit.

IMPORTANT – It is forbidden to put into partial or provisional operation.

6 PRODUCT MAINTENANCE

To keep the level of safety consistent and to guarantee maximum life of the entire automation it is necessary to maintain it regularly.

The maintenance must be performed in line with the safety instructions of this manual and according to what is set out by the laws and regulations in force. For the gear motor a programmed maintenance within no more than 6 months is required.

Maintenance operations:

- 01.** Disconnect any sources of electricity.
- 02.** Check the status of deterioration of all the materials which make up the automation with particular attention to signs of erosion or oxidation of the structural parts: replace the parts which do not provide sufficient guarantees.
- 03.** Check the screw connections are sufficiently tight.
- 04.** Check the bolt and endless screw are suitably greased.
- 05.** Check the wear of the moving parts and, if necessary, replace used parts.
- 06.** Reconnect the sources of electrical power and perform all the tests and checks envisaged in chapter 5.

For the other devices present in the system refer to the individual instruction manuals.

DISPOSAL OF THE PRODUCT

This product is an integral part of the automation, and therefore, they must be disposed of together.

As for the installation operations, at the end of the life of this product, the dismantling operations must be performed by qualified personnel.

This product is made from different types of materials: some can be recycled, others must be disposed of. Please inform yourselves on the recycling or disposal systems provided for by the laws in force in your area, for this category of product.

CAUTION! – some parts of the product can contain polluting or dangerous substances which, if dispersed in the environment, may cause serious harm to the environment and human health.

As indicated by the symbol at the side, it is forbidden to throw this product into domestic refuse. Therefore, follow the “separated collection” instructions for disposal, according to the methods provided for by local regulations in force, or redeliver the product to the retailer at the moment of purchase of a new, equivalent product.



CAUTION! – the regulations in force at local level may envisage heavy sanctions in case of abusive disposal of this product.

TECHNICAL FEATURES OF THE PRODUCT

CAUTIONS: • The technical features set out refer to an ambient temperature of 20°C (± 5°C). • Nice S.p.a. reserves the right to make alterations to the product any time it deems it necessary, keeping the same functionality and destination of use.

	WG4024	WG5024	WG4000	WG4000/V1	WG5000	WG5000/V1
Type	electromechanical gear motor for gates or doors with leaf opening					
Power input	24 V ⁻⁻⁻	24 V ⁻⁻⁻	230 V~ 50 Hz	120 V~ 60 Hz	230 V~ 50 Hz	120 V~ 60 Hz
Maximum absorption	3,5 A	3,5 A	1,5 A	1,5 A	1,5 A	2,5 A
Nominal absorption	2 A	2 A	0,5 A	0,5 A	0,5 A	1 A
Maximum absorbed power	85 W	85 W	200 W	200 W	200 W	200 W
Nominal absorbed power	50 W	50 W	130 W	130 W	130 W	130 W
Protection grade	IP 44	IP 44	IP 44	IP 44	IP 44	IP 44
Travel	320 mm	470 mm	320 mm	320 mm	470 mm	470 mm
Speed loadless	0,018 m/s	0,016 m/s	0,016 m/s	0,020 m/s	0,013 m/s	0,016 m/s
Speed loaded	0,013 m/s	0,012 m/s	0,012 m/s	0,015 m/s	0,010 m/s	0,012 m/s
Maximum thrust	1500 N	1500 N	1500 N	1500 N	1700 N	1700 N
Nominal thrust	500 N	500 N	500 N	500 N	600 N	600 N
Operating temperature	-20 °C to +50 °C					
Cycles h at nominal torque	40	40	30	30	30	30
Durability	estimated between 80,000 and 250,000 cycles of manoeuvres according to the conditions set out in Table 2					
Insulation class	A	A	F	F	F	F
Dimensions (mm)	770 x 98 x 95 h	920 x 98 x 95 h	770 x 98 x 95 h	770 x 98 x 95 h	920 x 98 x 95 h	920 x 98 x 95 h
Weight (kg)	6	6	6	6	6	6

Durability of the product

Durability is the average economic life of the product. The value of durability is strongly influenced by the demand index of the manoeuvres performed by the automatism: that is the sum of all the factors which contribute to the wear of the product (see Table 2).

To establish the probable durability of your automatism proceed as follows:

01. Calculate the demand index summing the values in percentage of the entries present in **Table 2** to each other;

02. In **Graph A**, from the value just found, trace a vertical line until you intersect the curve; from this point trace a horizontal line to cross the line of "cycles of manoeuvres". The value established is the estimated durability of your product.

The estimate of durability is performed on the basis of the design calculations and the results of tests carried out on prototypes. In fact, being an estimate, it does not give any guarantee on the actual duration of the product.

TABLE 2			
		Demand index	
		WG4024 WG4000 WG4000/V1	WG5024 WG5000 WG5000/V1
Leaf weight:	> 100 Kg	10 %	0 %
	> 200 Kg	20 %	10 %
	> 300 Kg	30 %	20 %
	> 400 Kg	-	30 %
Leaf length:	1 - 2 m	20 %	0 %
	2 - 3 m	-	10 %
	3 - 3,5 m	-	20 %
Operating temperature:		20 %	20 %
Blind leaf:		15 %	15 %
Installation in windy area:		15 %	15 %

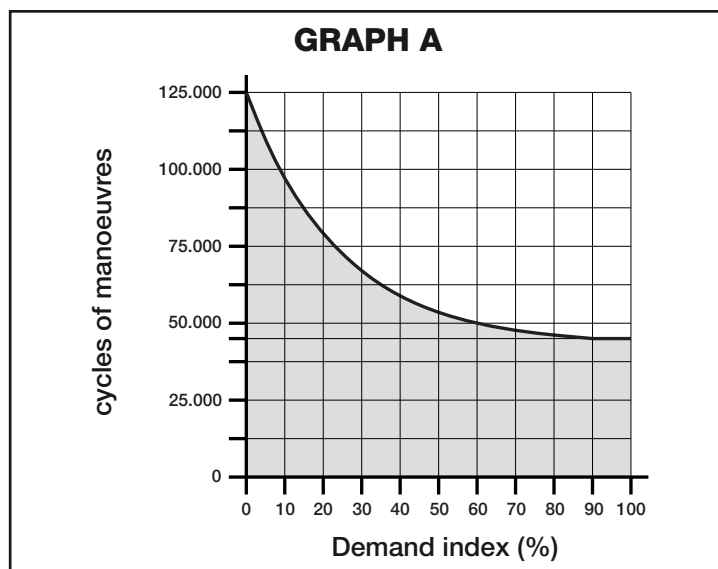

Example of calculation of durability of a Wingo WG5024 gear motor (refer to Table 2 and Graph A):

- leaf weight = 200 Kg (demand index= 10%)

- leaf length = 2.5 m (demand index = 20%)

- no other stress elements present

Total demand index = 20%

Durability estimate = 80.000 cycles of manoeuvre

CE DECLARATION OF CONFORMITY

Note - The content of the present declaration corresponds to the latest available revision, before the printing of the present manual, of the document registered at the head offices of Nice S.p.a. The present text has been readapted for publishing reasons.

Number: 143/WINGO

Revision: 4

The undersigned Lauro Buoro, managing director, declares under his sole responsibility that the following product:

Manufacturer's name: NICE s.p.a.

Address: Via Pezza Alta 13, Z.I. Rustignè, 31046 Oderzo (TV) Italy

Type: Electromechanical operator "WINGO" for swing gates

Models: WG4000, WG4000/V1, WG5000, WG5000/V1, WG4024, WG5024

Accessory: No accessory

conforms with the requirements of the following EC directives:

- 98/37/EC (89/392/EEC amended); DIRECTIVE 98/37/EC OF THE EUROPEAN PARLIAMENT AND COUNCIL of 22 June 1998 regarding the approximation of member state legislation relating to machinery

As established in directive 98/37/EC, the above-mentioned product may not be started up unless the machine in which the product is incorporated has been identified and declared as conforming to directive 98/37/EC.

Satisfies the essential requirements of the following Directives, as amended by the directive 93/68/EEC of the European Council of 22nd July 1993:

- 2006/95/EEC (ex directive 73/23/EEC); DIRECTIVE 2006/95/EEC OF THE EUROPEAN PARLIAMENT AND COUNCIL of 12 December 2006 regarding the approximation of member state legislation relating to electrical material intended for use within specific voltage limits

According to the following harmonised standards:

EN 60335-1:1994+A11:1995+A1:1996+A12:1996+A13:1998+A14:1998+A15:2000+A2:2000+A16:2001

- 2004/108/EEC (ex directive 89/336/EEC); DIRECTIVE 2004/108/EEC OF THE EUROPEAN PARLIAMENT AND COUNCIL of 15 December 2004 regarding the approximation of member state legislation relating to electromagnetic compatibility, repealing directive 89/336/EEC

According to the following harmonised standards: EN 61000-6-2:2005; EN 61000-6-3:2001+A11:2004

The product also complies with the applicable parts of the following standards:

EN 60335-1:2002+A1:2004+A11:2004+A12:2006+ A2:2006, EN 60335-2-103:2003, EN 13241-1:2003; EN 12453:2002; EN 12445:2002; EN 12978:2003

Oderzo, 24 November 2008

Lauro Buoro (Managing Director)

EN - OPERATION MANUAL

IT - MANUALE D'USO

FR - GUIDE DE L'UTILISATEUR

ES - MANUAL DE USO

DE - GEBRAUCHSANLEITUNG

PL - INSTRUKCJA OBSŁUGI

NL - GEBRUIKSHANDLEIDING

Instructions and cautions for the user of the WG4024-WG5024-WG4000-WG4000/V1-WG5000-WG5000/V1 gear motor

Before using the automation for the first time, have the fitter explain the origin of the residual risks, and dedicate a few minutes of your time to reading the instructions manual and cautions for the user provided by the fitter. Keep the manual for any future doubt and deliver it to any new proprietor of the automation.

CAUTION! –Your automation is a machine which faithfully performs your commands; a wrong or improper use will make it dangerous:

– **Do not command the movement of the automation if people, animals or things are within its range of action.**

– **It is totally forbidden to touch parts of the automation while the gate or door is moving!**

– **Transit is allowed only if the gate or door is completely open with the leaves stopped!**

• **Children:** an automation system guarantees a high level of safety, preventing the movement in the presence of people or things with its detection systems, and guaranteeing an always predictable and safe activation. It is in any case prudent to forbid children to play close to the automation and, to avoid accidental activations, do not leave the remote control within their reach: it is not a toy!

• The product is not designed to be used by people (including children) whose physical, sensorial, or mental abilities are reduced, or those without experience or knowledge, unless they have been able to benefit, through intermediation of a person responsible for their safety, of supervision or instructions regarding the use of the product.

• **Anomalies:** As soon as you notice some anomalous behaviour by the automation, cut off the power to the system and unblock it manually. Do not attempt to perform any repair work, but ask the assistance of your trusted fitter: meanwhile the system can work as an unautomated opening, once the gear motor has been unblocked as described below.

• **Maintenance:** As with each machine your automation needs periodic maintenance so that it can function as long as possible and in complete safety. Agree a periodic maintenance plan with your fitter; Nice recommends maintenance every 6 months for normal domestic use, but this period may vary depending on the intensity of use: Any control, maintenance or repair work must be performed by qualified personnel.

• Even if you consider yourself able to perform the work, do not modify the system and the programming parameters or adjust the automation: it is the responsibility of the fitter.

• The inspection, periodic maintenance work and any repairs must be documented by the person who performs them and these documents must be kept by the owner of the system. The only work you can perform and which we recommend doing periodically is cleaning of the glass of the photocells and the removal of any leaves or stones which may obstruct the automatism. To prevent someone activating the gate, before proceeding, remember to unblock the automatism (as described below) and to clean it only with a sponge slightly dampened in water.

• **Disposal:** At the end of the life of the automation, ensure it is dismantled by qualified personnel and that the materials are recycled or disposed of according to local regulations in force.

• In the event of breakage or black out: As you await for the fitter to perform the work or for the electricity to return if the system is not equipped with buffer batteries, the automation can still be used. It is necessary to manually unblock the gear motor (see "Unblocking or blocking the gear motor") and move the gate leaf manually as required.

UNBLOCKING AND BLOCKING THE GEAR MOTOR MANUALLY

The gear motor is equipped with a mechanical system which allows to open and close the gate manually. These operations must be performed during electrical black outs or operating anomalies.

IMPORTANT! – The gear motor must only be blocked or unblocked when the leaf is stopped.

If there is an electric lock on the automation ensure the electric lock is unlocked before moving the leaf.

UNBLOCKING the gear motor manually (fig. A):

01. Slide the protection membrane and insert the key turning it clockwise;
02. Pull the handle upwards, accompanying it;
03. At this point, manually move the gate leaf in the position desired.

BLOCKING the gear motor manually;

01. Close the handle and turn the key anti-clockwise;
02. Remove the key and close the protection membrane.

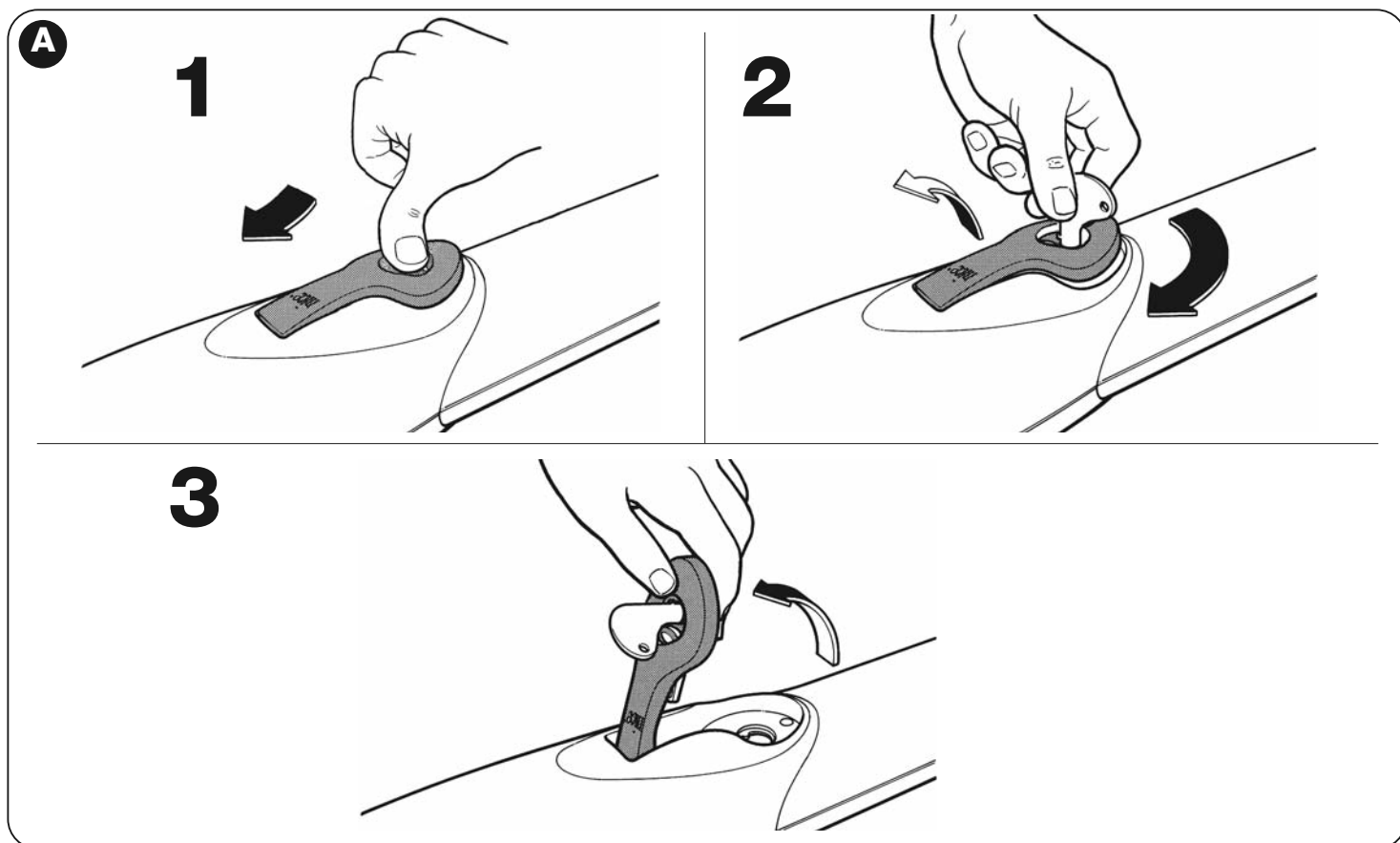

EN - Images

IT - Immagini

FR - Images

ES - Imágenes

DE - Bilder

PL - Zdjęcia

NL - Afbeeldingen

- EN - **GRAPH 1** "Limits of use of the product"
- FR - **GRAPHIQUE 1** "Limites d'utilisation du produit"
- DE - **GRAPHIK 1** "Verwendungsgrenzen des Produkts"
- NL - **GRAFIEK 1** "Gebruiksbeperkingen van het product"

- IT - **GRAFICO 1** "Limiti d'impiego del prodotto"
- ES - **GRÁFICO 1** "Límites de empleo del producto"
- PL - **SCHEMAT 1** "Ograniczenia używania produktu"

WG4024 - WG4000 - WG4000/V1

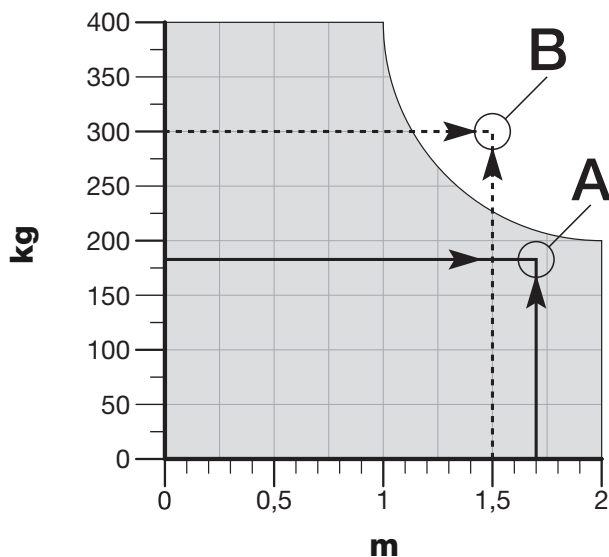

WG5024 - WG5000 - WG5000/V1

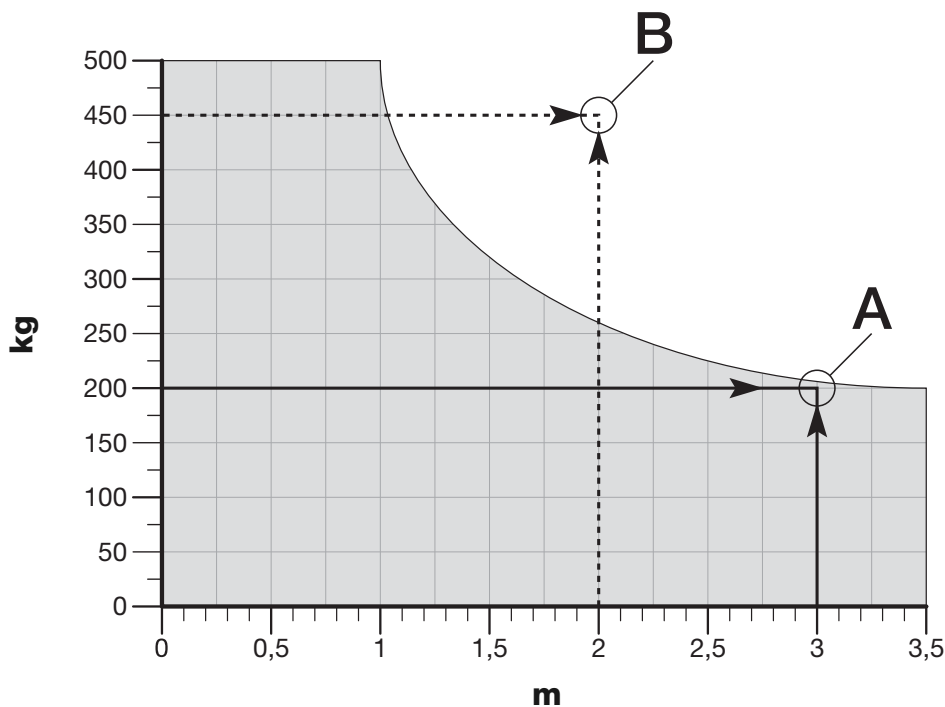

kg:

- EN - Maximum weight of the gate leaf
- IT - Peso massimo dell'anta del cancello
- FR - Poids maximum du vantail du portail
- ES - Peso máximo de la hoja de la puerta
- DE - Höchstgewicht des Torflügels
- PL - Ciężar maksymalny skrzydła bramy
- NL - Maximum gewicht van de vleugel van het hekwerk

m:

- EN - Maximum length of the gate leaf
- IT - Lunghezza massima dell'anta del cancello
- FR - Longueur maximum du vantail du portail
- ES - Longitud máxima de la hoja de la puerta
- DE - Höchstlänge des Torflügels
- PL - Długość maksymalna skrzydła bramy
- NL - Maximum lengte van de vleugel van het hekwerk

WG4024 - WG4000 - WG4000/V1

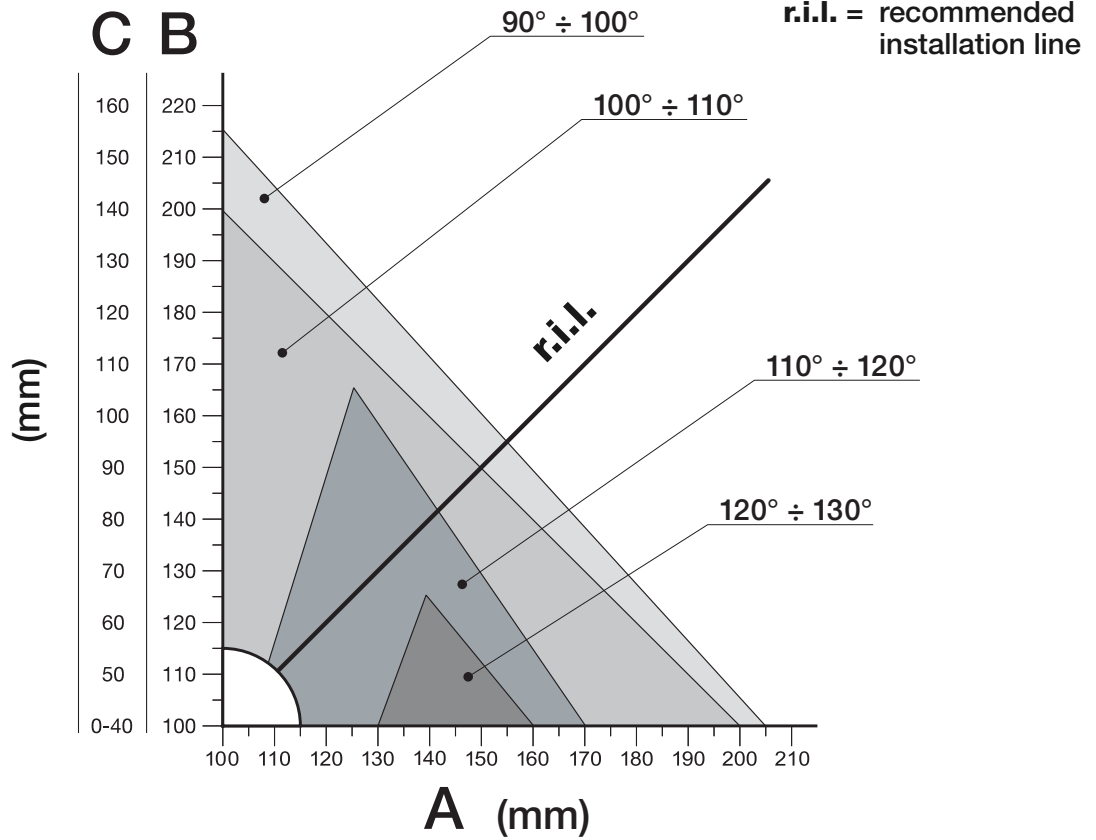

WG5024 - WG5000 - WG5000/V1

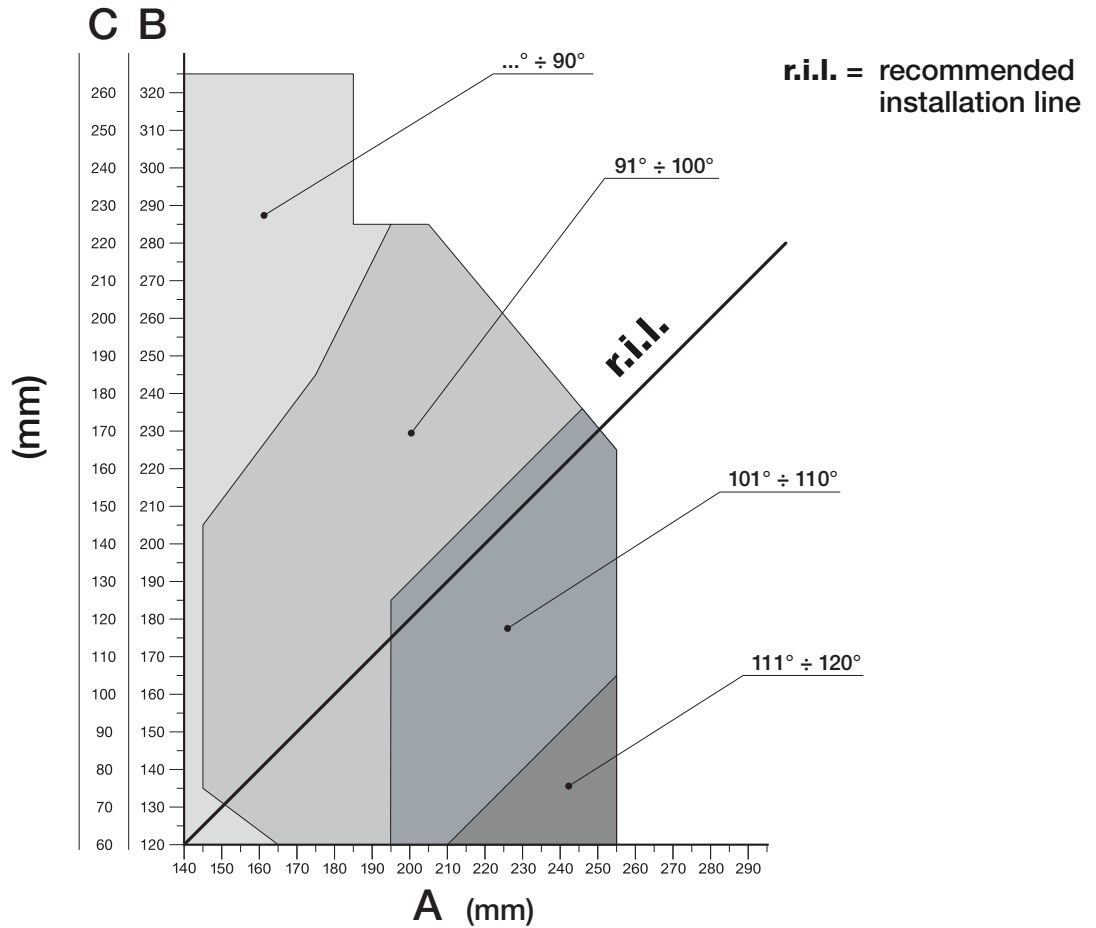

1

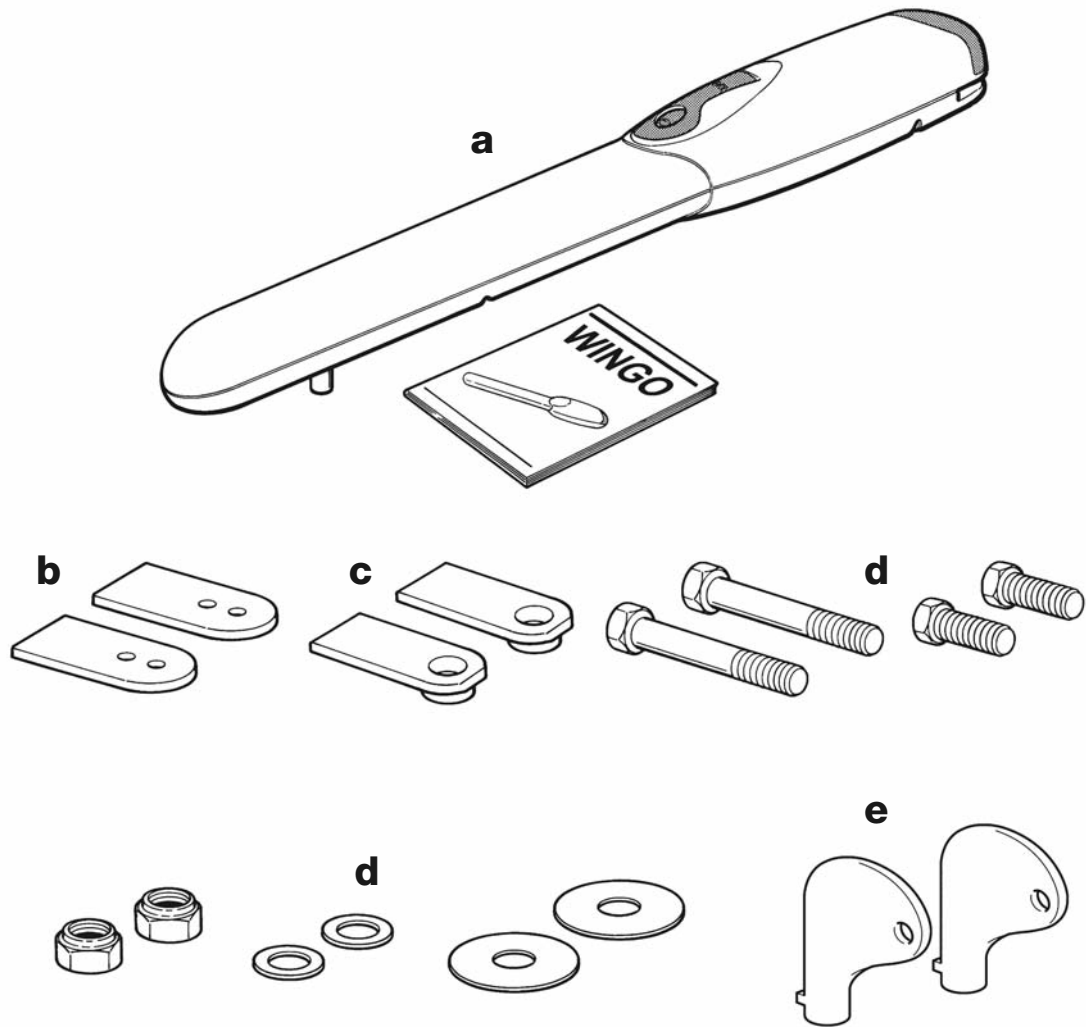

2

WG4024 - WG4000 - WG4000/V1

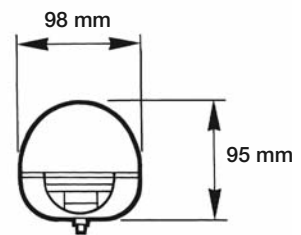
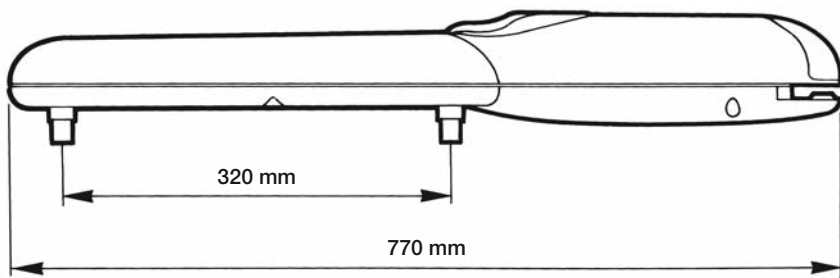

WG5024 - WG5000 - WG5000/V1

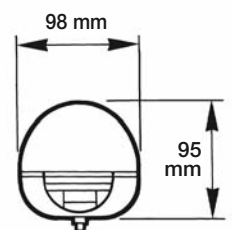
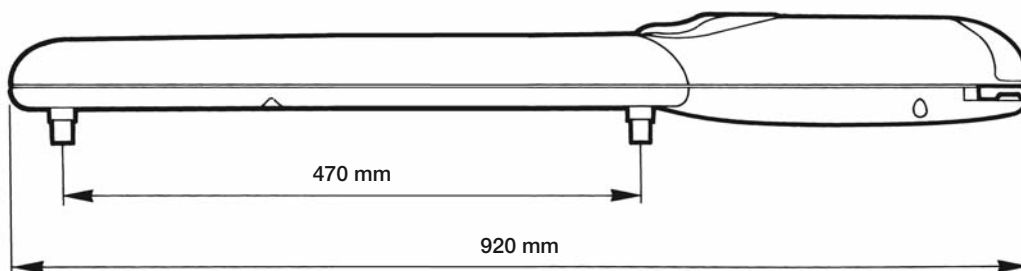

3

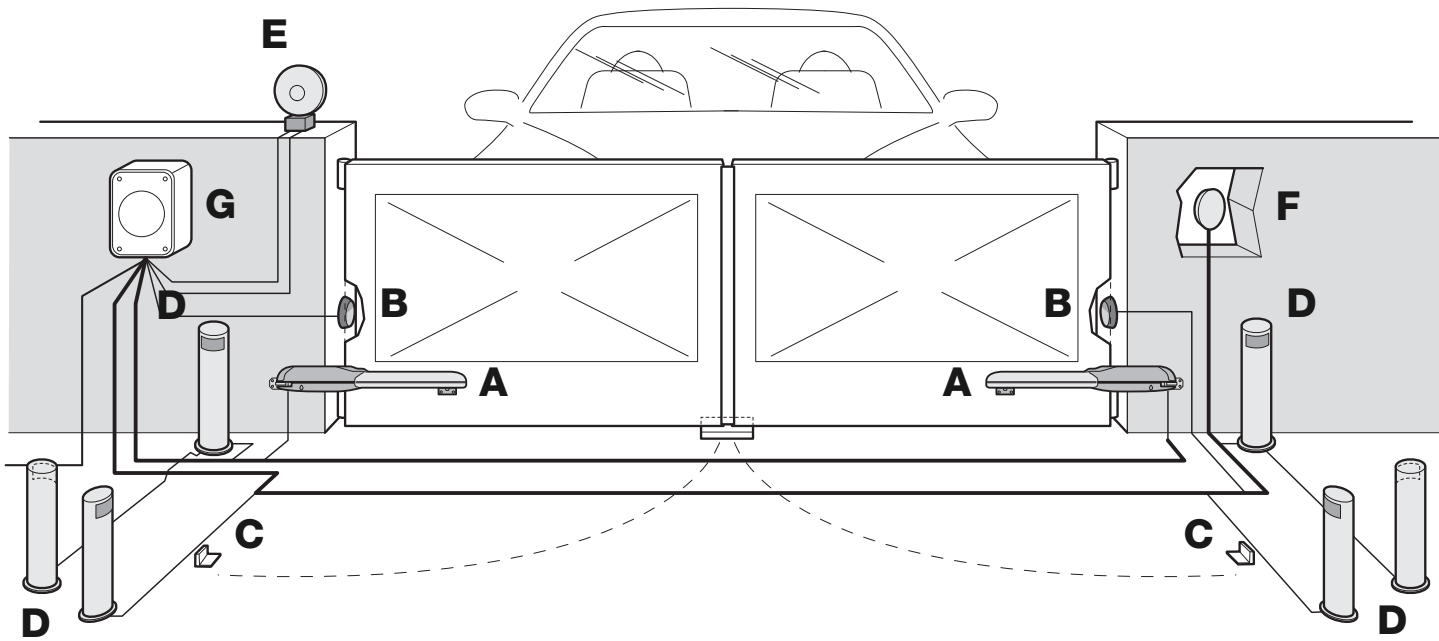

4

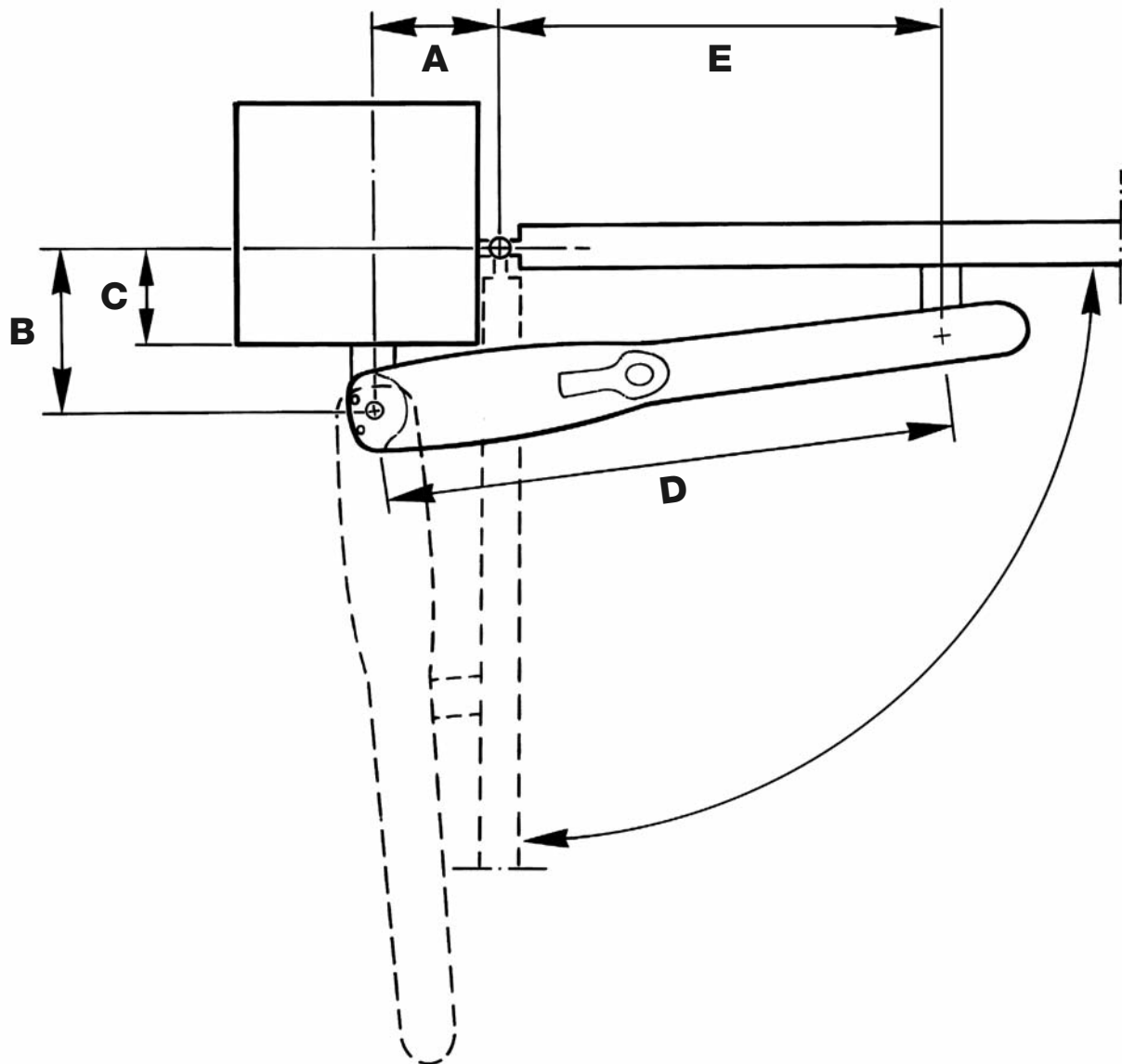

5

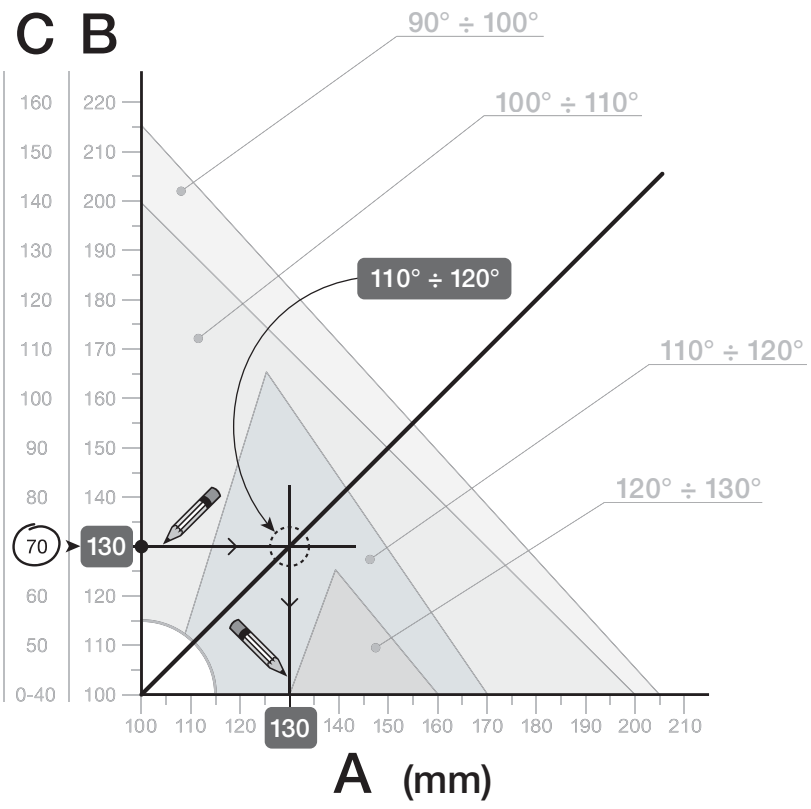

6

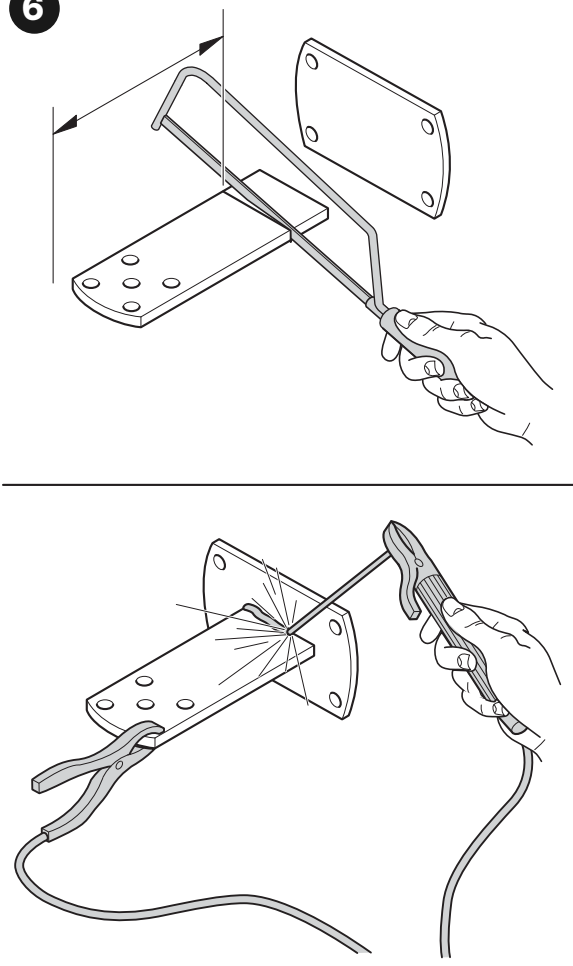

7

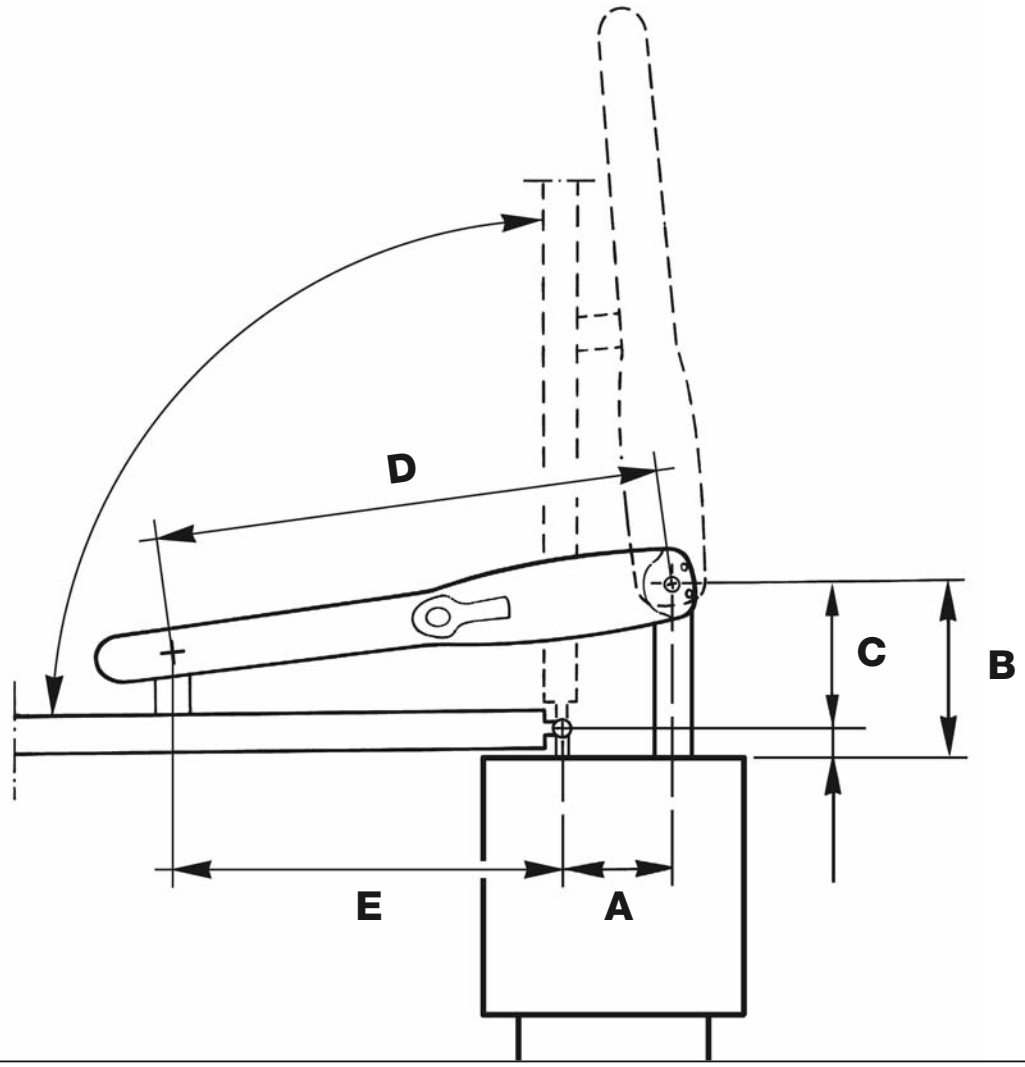

8

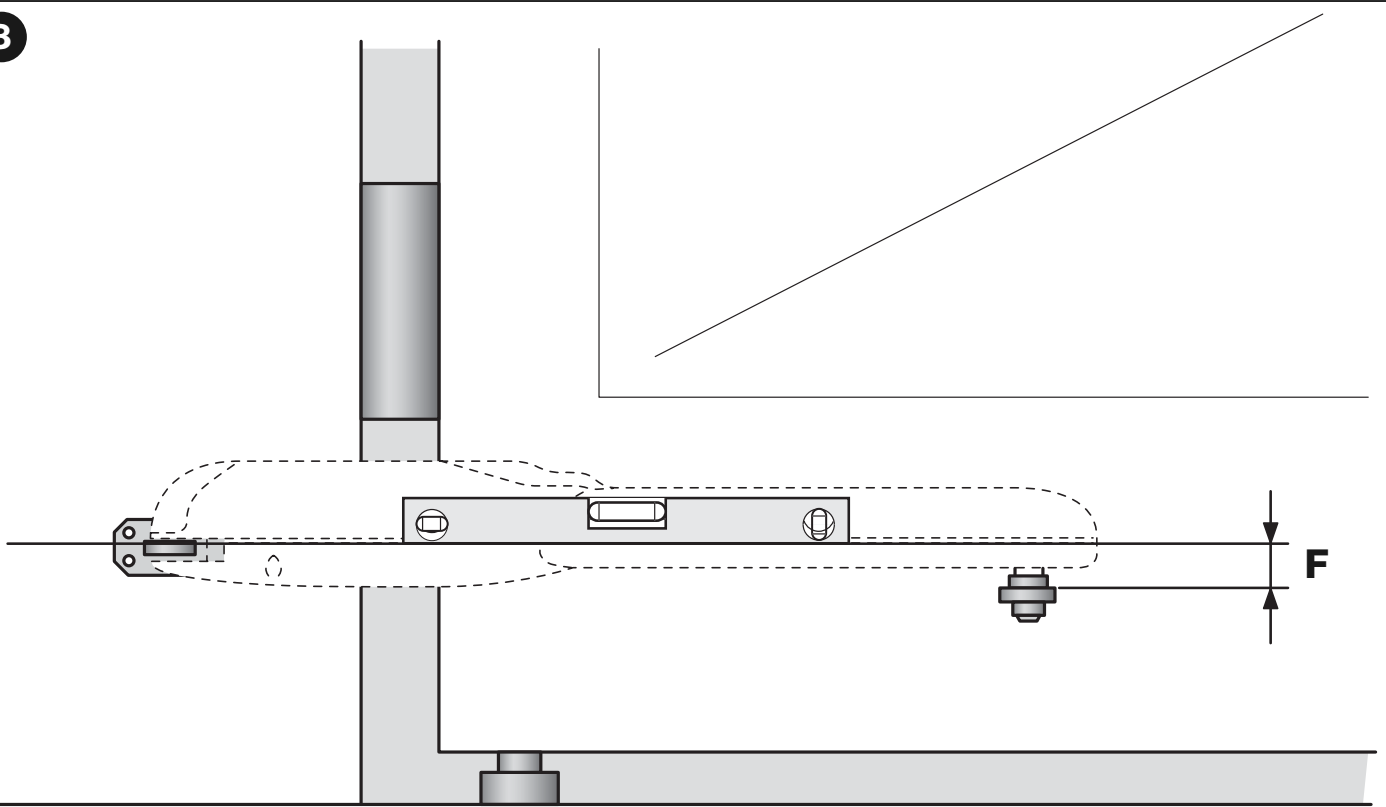

WG4025 - WG4000 - WG4000/V1: F = 30 mm

WG5025 - WG5000 - WG5000/V1: F = 30 mm

9

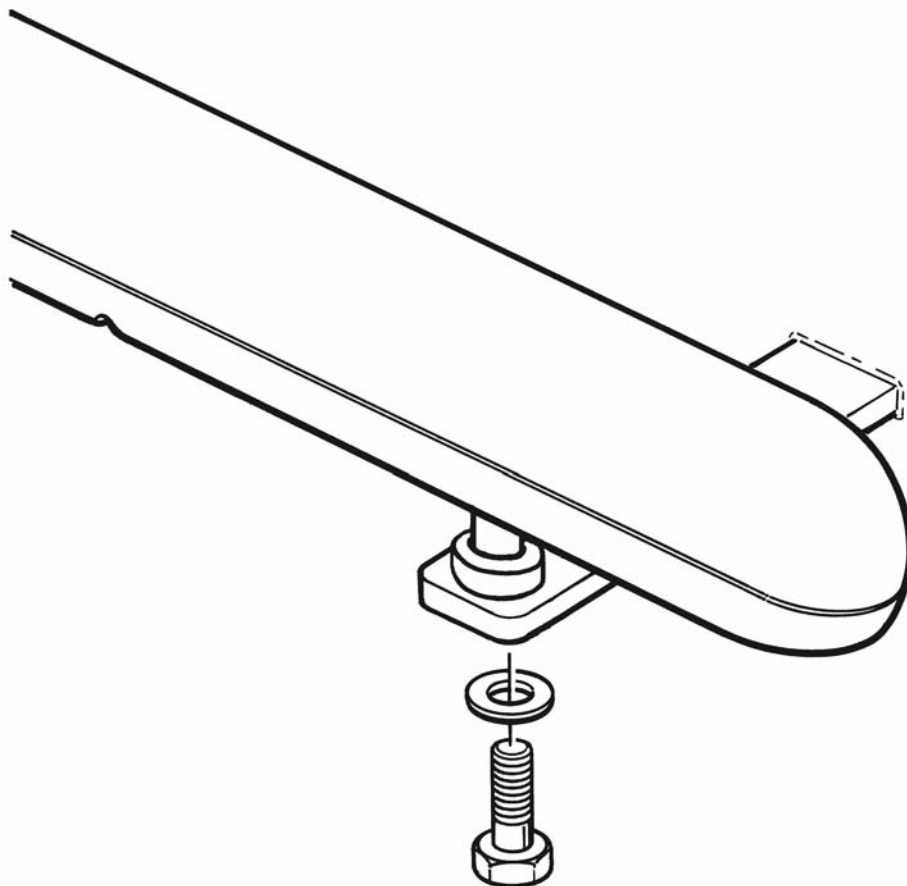

10

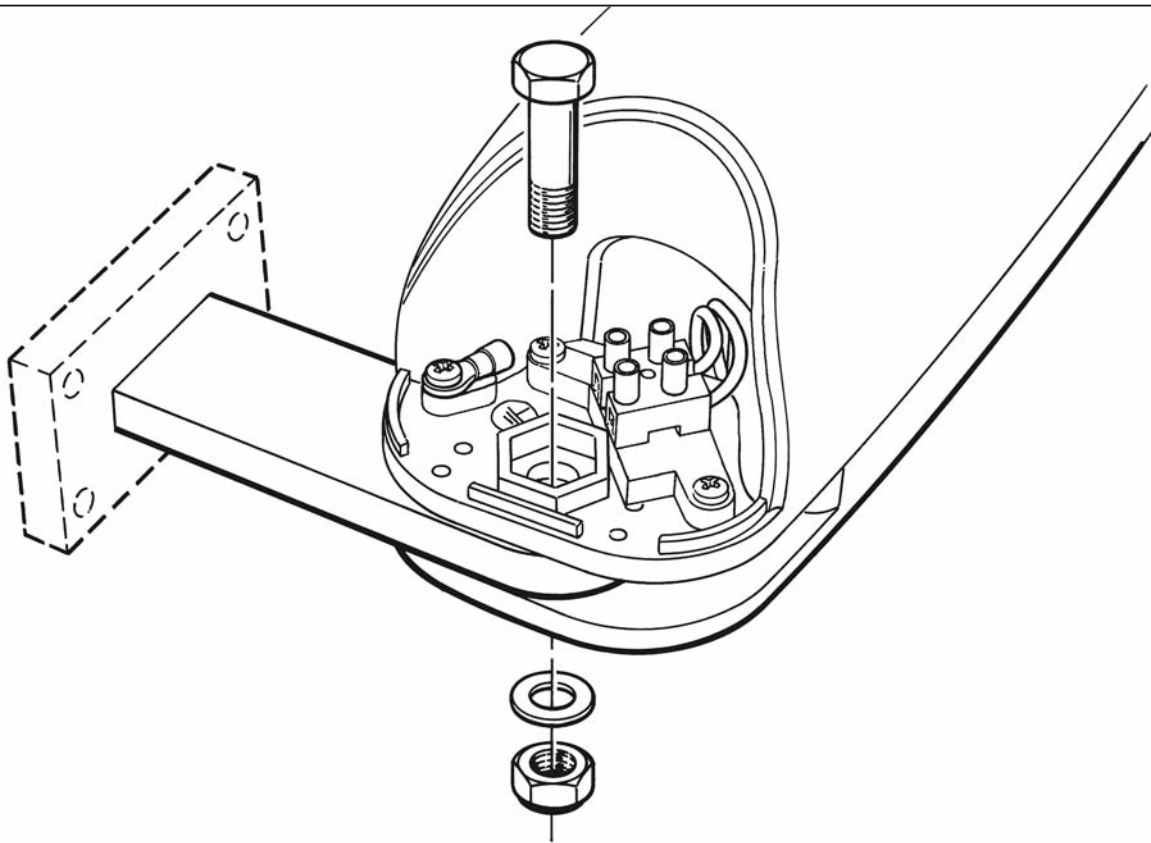

11

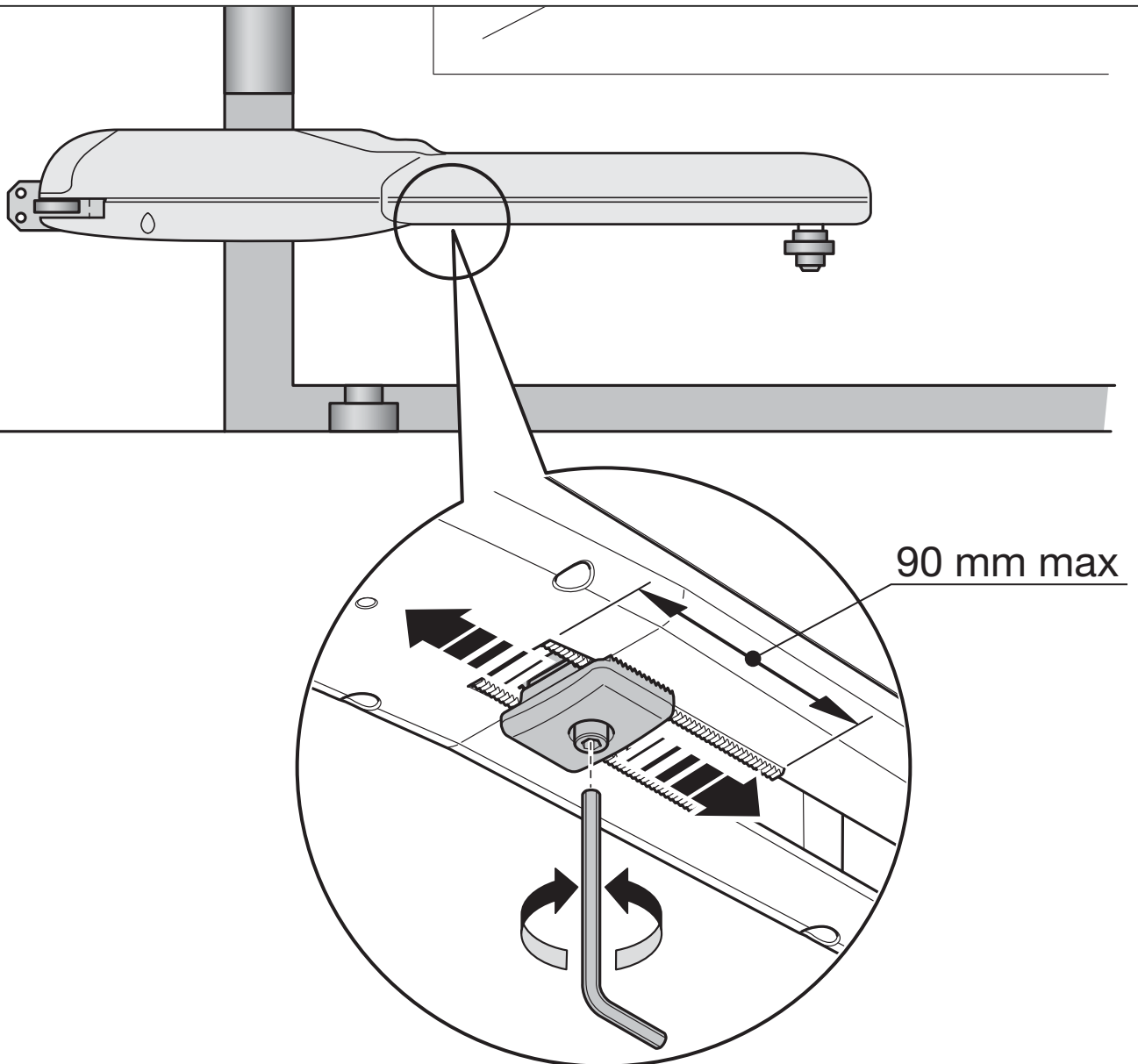

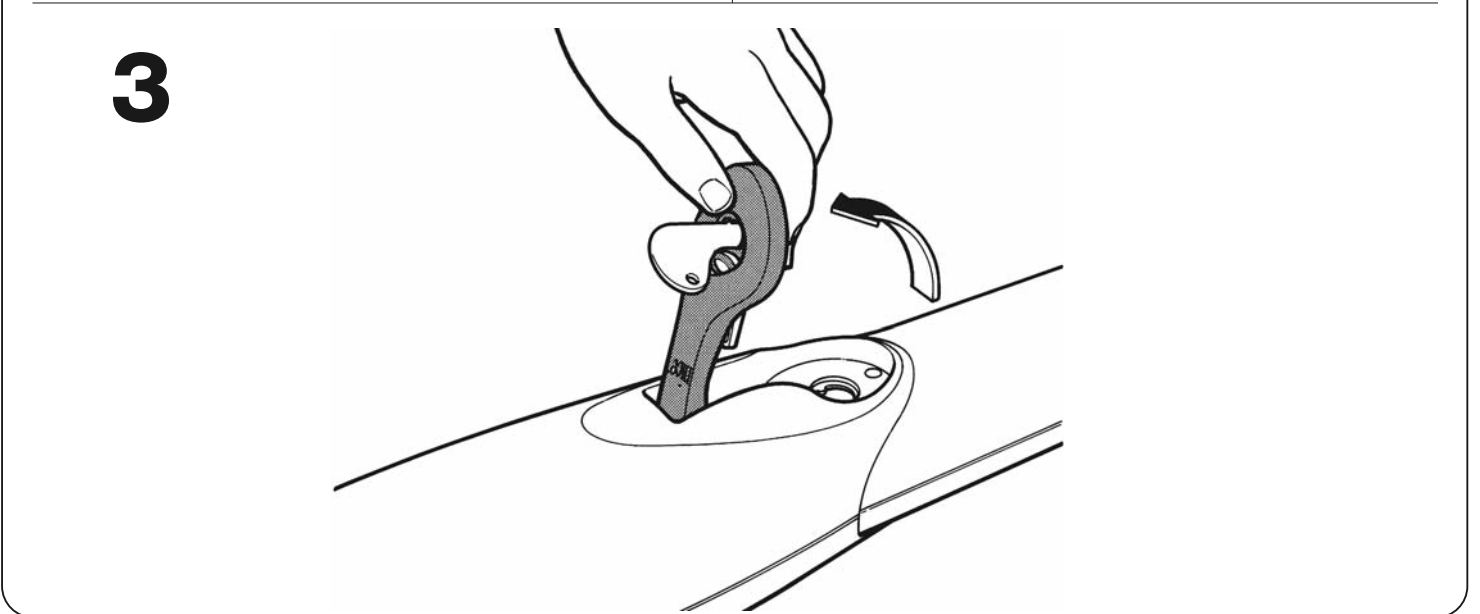
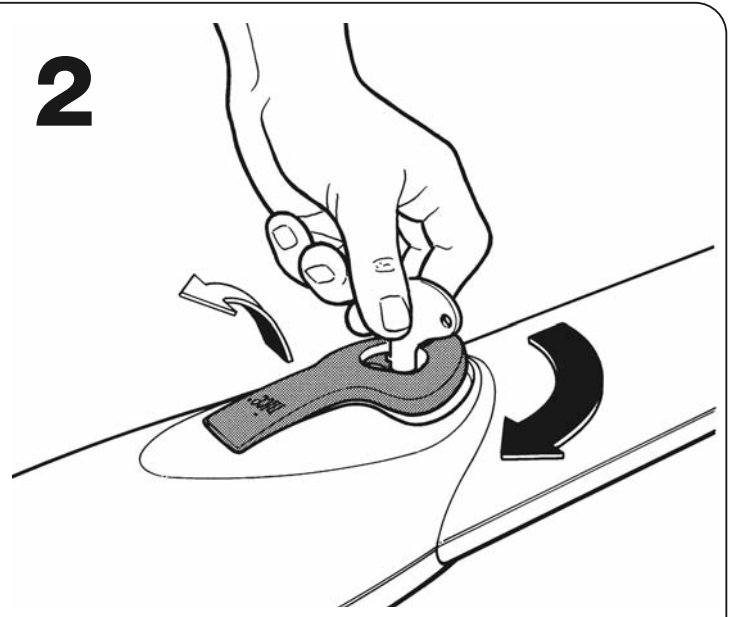
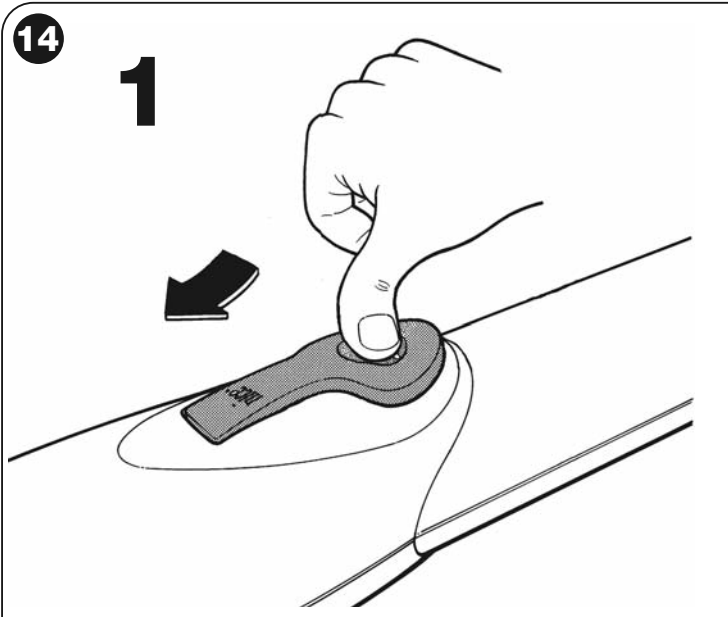
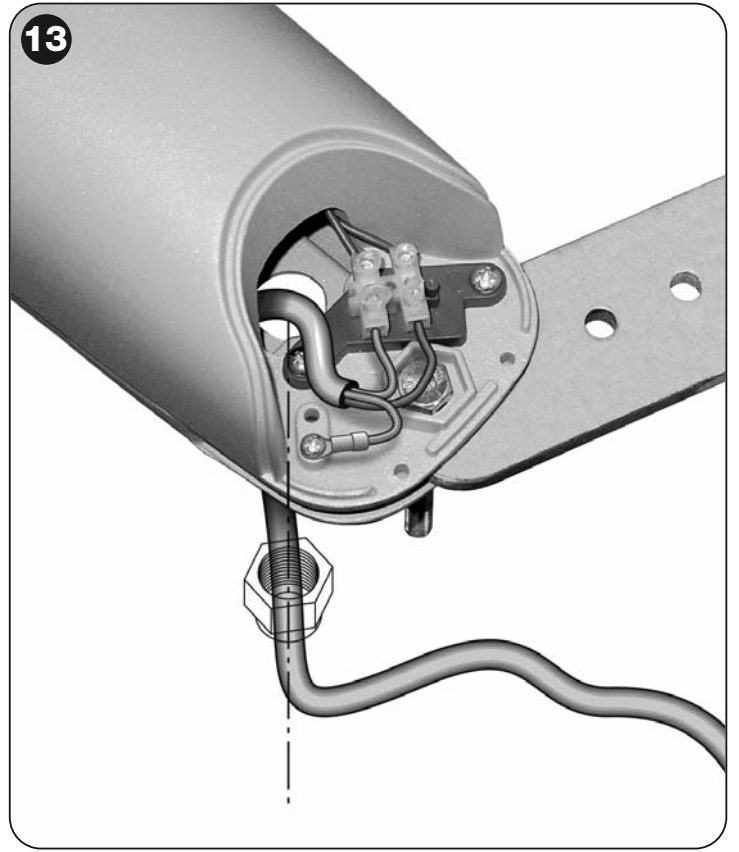
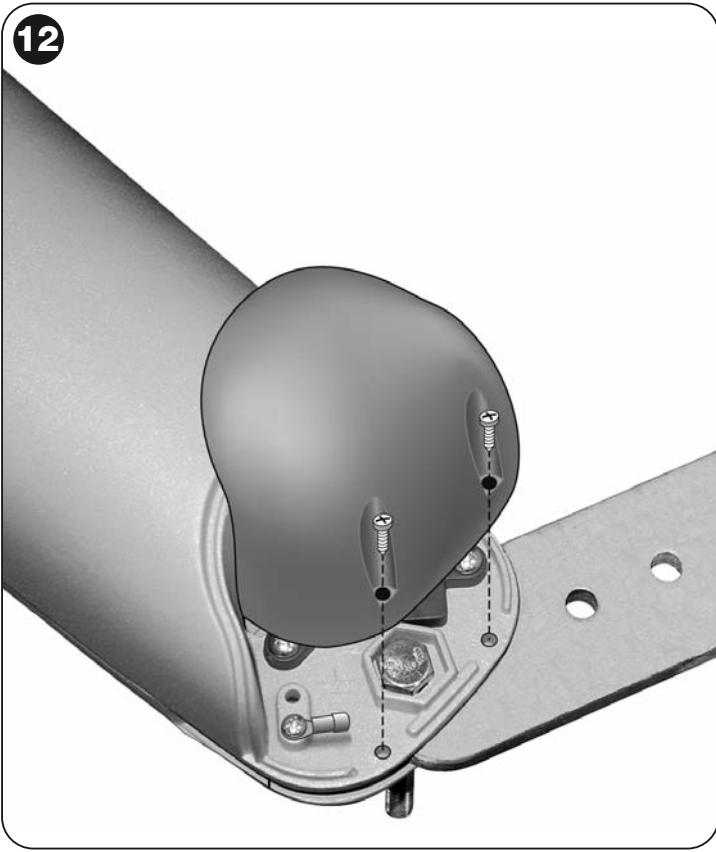



Nice SpA
Oderzo TV Italia
info@niceforyou.com

www.niceforyou.com

Moon

CE

**Control unit
MC424**

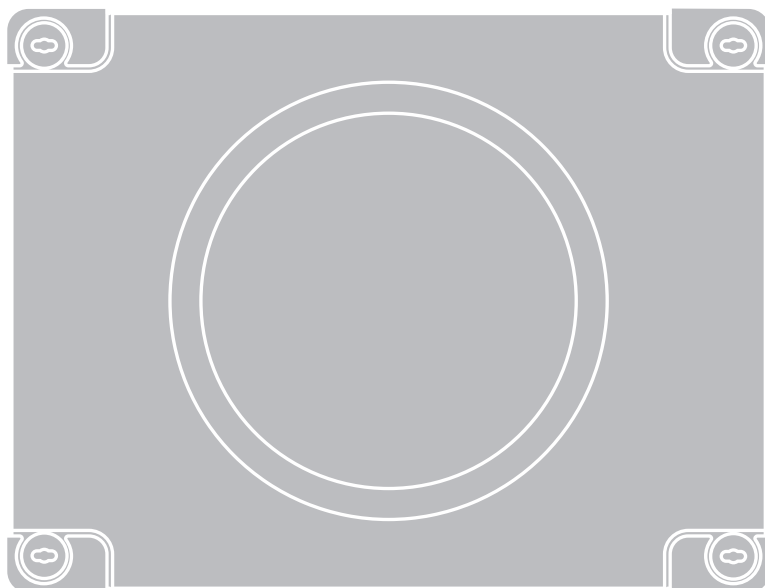

EN - Instructions and warnings for installation and use

IT - Istruzioni ed avvertenze per l'installazione e l'uso

FR - Instructions et avertissements pour l'installation et l'utilisation

ES - Instrucciones y advertencias para la instalación y el uso

DE - Installierungs-und Gebrauchsanleitungen und Hinweise

PL - Instrukcje i ostrzeżenia do instalacji i użytkowania

NL - Aanwijzingen en aanbevelingen voor installatie en gebruik

Nice

Summary

GENERAL SAFETY WARNINGS AND PRECAUTIONS	1
1 – PRODUCT DESCRIPTION	1
2 – INSTALLATION	1
2.1 - PRELIMINARY CHECKS FOR INSTALLATION	2
2.2 - PRODUCT APPLICATION LIMITS	2
2.3 - INSTALLATION	2
2.4 - ELECTRICAL CONNECTIONS	2
2.4.1 - Notes on connections	3
2.4.2 - Type of ALT input	3
2.4.3 - Examples of photocell connections: with the STANDBY function active and the Phototest function disabled	3
2.4.4 - Examples of photocell connections: with the Phototest function active and the STANDBY function disabled	3
2.5 - INITIAL START-UP AND ELECTRICAL CONNECTIONS	3
2.6 - AUTOMATIC LIMIT SWITCH SEARCH	3
3 – TESTING AND COMMISSIONING	4
3.1 - TESTING	4
3.2 - COMMISSIONING	4
4 – DIAGNOSTICS	4
5 – PROGRAMMING	4
5.1 - PRESET FUNCTIONS	4
5.2 - PROGRAMMABLE FUNCTIONS	4
5.2.1 - Direct programming	4
5.2.2 - First level programming: first part	4
5.2.3 - First level programming: second part	5
5.2.4 - Second level functions	5
5.3 - PROGRAMMING MODES	5
5.3.1 - First level programming: functions	6
5.3.2 - Second level programming: parameters	6
5.3.3 - Deletion of memory	6
5.3.4 - Example of first level programming	7
5.3.5 - Example of second level programming	7
5.3.6 - Programming diagram	8
6 – FURTHER DETAILS: accessories	9
6.1 - CONNECTING A RADIO RECEIVER	9
6.2 - CONNECTING MODEL PS124 BUFFER BATTERY	9
6.3 - CONNECTING THE SOLEMYO SYSTEM	9
7 – TROUBLESHOOTING (troubleshooting guide)	9
8 – PRODUCT MAINTENANCE	9
DISPOSAL OF THE PRODUCT	9
TECHNICAL CHARACTERISTICS OF THE PRODUCT	10
EC DECLARATION OF CONFORMITY	10
RADIO RECEIVER: SMXI - SMIXS	11
1 - PRODUCT DESCRIPTION	11
2 - AERIAL INSTALLATION	11
3 - MEMORISING A REMOTE CONTROL	11
4 - DELETING ALL TRANSMITTERS	12
TECHNICAL CHARACTERISTICS OF THE PRODUCT	12
IMAGES	I - VII

Safety warnings

- **IMPORTANT!** – This manual contains important instructions and warnings for personal safety. Incorrect installation could cause serious physical injury. Read all parts of the manual carefully before starting work. If in doubt, interrupt installation and contact the Nice Service Centre for clarifications.
- **IMPORTANT!** – Important instructions: keep this manual in a safe place to enable future product maintenance and disposal procedures.

Installation warnings

- Before commencing installation, check that the product is suitable for the intended kind of use (see paragraph 2.2 “Limits of use” and chapter “Product technical specifications”). If not suitable, do NOT proceed with installation.
- During installation, handle the product with care, avoiding the risk of crushing, impact, dropping or contact with any type of liquid. Never place the product near sources of heat or expose to naked flames. This may damage product components and cause malfunctions, fire or hazardous situations. If this occurs, suspend installation immediately and contact the Nice Service Centre.
- Never make modifications to any part of the product. Operations other than as specified can only cause malfunctions. The manufacturer declines all liability for damage caused by makeshift modifications to the product.
- The product should not be used by children or people with impaired physical, sensorial or mental capacities or who have not received adequate training in the safe use of the product.
- On the power line to the system, install a device for disconnection from the power mains with a gap between contacts that assures complete disconnection in the conditions of overvoltage category III.
- Connect the control unit to an electric power line equipped with an earthing system.
- The product's packaging materials must be disposed of in full compliance with local regulations.

1 PRODUCT DESCRIPTION

The MC424 control unit has been designed to control Wingo 24 V electro-mechanical actuators, for automated swing gates or doors. **IMPORTANT!** – Any uses other than those specified herein or in environmental conditions other than as stated in this manual are to be considered improper and are strictly prohibited!

The MC424 control unit operates on the basis of a current sensitivity system which checks the load of the motors connected to it. The system automatically detects travel stops, memorises the running time of each motor and recognises obstacles during normal movement. This feature makes installation easier as there is no need to adjust the working times nor the leaf delay.

The control unit is pre-programmed for the normal functions, while more specific functions can be chosen following a simple procedure (see chapter 5).

The control unit is designed to be powered by PS124 buffer batteries as emergency power supply in the event of a mains power failure (for further information see chapter 6.2). It is also designed to be connected to the “Solemyo” solar energy system (for further information see chapter 6.3).

2 INSTALLATION

In order to explain certain terms and aspects of an automatic 2-leaf swing door or gate system refer to the typical system shown in **fig 1**.

Key to fig. 1:

1. Wingo 24 V electromechanical actuator
2. Electromechanical actuator
3. Lucy24 flashing light
4. Key-operated selector switch
5. “PHOTO” pair of photocells
6. “FOTO1” pair of photocells
7. “PHOTO2” pair of photocells
8. Control unit

In particular, please note that:

- Refer to the product instructions for the characteristics and connection of the photocells.
- Activation of the “PHOTO” pair of photocells have no effect on the gate during opening, while they reverse movement during closing.

- Activation of the “PHOTO 1” pair of photocells stops both the opening and closing manoeuvres.
- Activation of the “PHOTO2” pair of photocells (connected to the suitably programmed AUX input) has no effect during closing while they invert movement during opening.

To check the parts of the control unit see fig. 2.

Key to fig. 2:

- A.** 24V power supply connector
- B.** M1 motor connector
- C.** PS124 buffer battery connector / Solemyo solar energy supply system (for further details see chapter 6.3)
- D.** 500mA F type services fuse
- E.** Selector switch for delaying the opening of motor M1 or M2
- F.** M2 motor terminal
- G.** Flashing light output terminal
- H.** Gate open indicator or electric lock output terminal
- I.** 24Vdc terminals for services and phototest
- L.** Input terminals
- L1...L5.** Input and programming LEDs
- M.** Terminal for radio aerial
- N.** “SM” radio receiver connector
- O.** Programming/diagnostics connector
- P1, P2, P3.** Programming buttons and LEDs

2.1 - Preliminary checks for installation

Before proceeding with installation, check the condition of the product components, suitability of the selected model and conditions of the intended installation environment:

- Ensure that all conditions of use remain within the limits of product application and within the “Product technical specifications”.
- Ensure that the selected installation environment is compatible with the overall dimensions of the product (fig. 3).
- Ensure that the selected surfaces for product installation are solid and guarantee a stable fixture.
- Make sure that the fixing zone is not subject to flooding. If necessary, mount the product raised from the ground.
- Ensure that the space around the product enables easy and safe completion of manual manoeuvres.
- Make sure that the automation is provided with mechanical stops on both closing and opening.

2.2 - Product application limits

The product may be used exclusively with Wingo 24 V gearmotors.

2.3 - Installation

To install the control unit, proceed as shown in fig. 4. Also observe the following warnings:

Key to figs. 2 - 5a - 5b - 5c:

Terminals	Function	Description	Type of cable
L - N - ⊕	Power supply line	Mains power supply	3 x 1,5 mm ²
1÷3	Motor 1	M1 motor connection	3 x 1,5 mm ²
1÷3	Motor 2	M2 motor connection (Note 1)	3 x 1,5 mm ²
4÷5	Flashing light	Connection of flashing light 24 V ⁼⁼ max 25 W	2 x 1 mm ²
6÷7	Open Gate indicator / Elect.Lock	Connection for Open Gate Indicator 24 V ⁼⁼ max 5 W or Electric lock 12 V ⁼⁼ max 25 VA (“See chapter 5 - Programming”)	SCA: 2 x 0,5 mm ² Electric lock: 2 x 1 mm ²
8	Common 24 V ⁼⁼ (with standby / phototest)	Power Supply +24 V ⁼⁼ for TX photocells with phototest (max. 100 mA); “COMMON” for all inputs, safety, with STAND BY function activated (Note 2)	1 x 0,5 mm ²
9	0 V ⁼⁼	Power supply 0V ⁼⁼ for services	1 x 0,5 mm ²
10	24 V ⁼⁼	Power input for services, without “Standby” (24 V ⁼⁼ max 200 mA)	1 x 0,5 mm ²
11	Common 24 V ⁼⁼	Common for all inputs (+24 V ⁼⁼) without “Standby”	1 x 0,5 mm ²
12	STOP	Input with STOP function (emergency, safety shutdown) (Note 3)	1 x 0,5 mm ²
13	PHOTO	NC Input for safety devices (photocells, sensitive edges)	1 x 0,5 mm ²
14	PHOTO 1	NC Input for safety devices (photocells, sensitive edges)	1 x 0,5 mm ²
15	STEP BY STEP	Input for cyclical functioning (OPEN-STOP-CLOSE-STOP)	1 x 0,5 mm ²
16	AUX	Auxiliary input (Note 4)	1 x 0,5 mm ²
17÷18	Aerial	Connection for the radio receiver aerial	screened cable type RG58

Note 1 – This is not used for single leaf gates (the control unit automatically recognises if only one motor has been installed).

Note 2 – The “Stand By” function serves to reduce consumptions. For further details on the electrical connections refer to paragraph 2.4.1 “Stand by/Phototest connection” and for programming refer to chapter 5.2.3 “Stand by/Phototest function”.

Note 3 – The STOP input can be used for “NC” or constant resistance 8.2 kΩ contacts (please refer to the “Programming” chapter)

Note 4 – The AUX factory auxiliary input is programmed with the “Partial open type 1” function but can be programmed with any of the following functions:

Function	Input type	Description
PARTIAL OPEN TYPE 1	NO	Fully opens the upper leaf
PARTIAL OPEN TYPE 2	NO	Opens the two leaf half way
OPEN	NO	Only carries out the opening manoeuvre
CLOSE	NO	Only carries out the closing manoeuvre

• The control unit is supplied in an enclosure that if correctly installed assures an IP54 protection rating. The control unit is therefore suitable for installation outdoors.

• Fix the control unit to a flat, vertical, non-removable surface that is adequately protected from potential impacts. **Important!** – The bottom of the control unit must be at least 40 cm from the ground.

• Insert the dedicated cable clamps or pipe glands into the lower part of the enclosure (fig. 4). **Important!** – If the cable protection tubes end in a pit, it is likely that condensation will form inside the control unit, which will damage the electronic board. In this case, protect the control unit adequately so as to prevent the formation of condensation.

• The cable clamps can be inserted on the long side of the enclosure only if the control unit is installed in a protected indoor environment.

To install the other devices present in the automation, refer to the relevant instruction manuals.

2.4 - Electrical connections

IMPORTANT!

– All electrical connections must be made with the unit disconnected from the mains power supply and with the buffer battery disconnected, if present in the automation.

– Connections must be made exclusively by qualified personnel.

– Make sure that all the electric cables used are of a suitable type.

01. Loosen the screws of the cover.

02. Prepare the electrical cable routing holes.

03. Connect the cables as shown in the wiring diagram in fig. 5. To connect the electric power cable, see fig. 6. **Note** – To facilitate cable connections, the terminals can be removed from their seats.

• With the exception of the photocell inputs when the PHOTOTEST function is activated, if the inputs of the NC (Normally Closed) contacts are not in use they should be jumped with the “COMMON” terminal. Refer to paragraph 2.4.3 for further information.

• If there is more than one NC contact on the same input, they must be connected in SERIES.

• If the inputs of the NO (Normally Open) contacts are not used they should be left free.

• If there is more than one NO contact on the same input, they must be connected in PARALLEL.

• The contacts must be electromechanical and potential-free. Stage connections, such as those defined as “PNP”, “NPN”, “Open Collector”, etc. are not allowed.

• If the leaves overlap, use jumper E (Fig. 6) to select which motor starts up first during opening.

PHOTO 2	NC	PHOTO 2 function
DISABLED	—	No function

2.4.1 - Notes about connections

Most connections are extremely simple and many of them are direct connections to a single user point or contact. The following figures show examples of how to connect external devices:

• Stand By / Phototest connection

The Stand-by function is active as standard. It is excluded automatically only when the Phototest function is activated. **Note** - The Stand-by and Phototest functions are alternatives as one excludes the other.

The Stand-by function allows consumptions to be reduced. Three types of connections can be obtained:

- with "stand by" active (**energy saving**); see electrical diagram in **fig. 5a**
- standard connection: without "Stand by" and without "Phototest"; see electrical diagram in **fig. 5b**
- without "Stand by" and with "Phototest"; see electrical diagram in **fig. 5c**

When the "Stand-by" function is active, 1 minute after the end of a manoeuvre the control unit goes into Stand-by, turning off the Inputs and Outputs to reduce consumptions. The status is indicated by the "OK" LED which begins to flash more slowly. **WARNING** – If the control unit is powered from a photovoltaic panel ("Solemyo" system) or a buffer battery, the "Stand-by" function must be activated as shown in the electrical diagram in **fig. 5a**.

When the "Stand-by" function is not required, the "Phototest" function may be activated. This verifies at the beginning of a manoeuvre that the connected photocells operate correctly. To use this function, first connect the photocells appropriately (see electrical diagram in **fig. 5c**) and then activate the function.

Note – When the phototest is activated, the inputs subjected to the test procedure are PHOTO, PHOTO1 and PHOTO2. If one of these inputs is not used it must be connected to terminal no. 8.

• Key switch connection

Example 1 (fig. 7a): How to connect the switch in order to perform the STEP-BY-STEP and STOP functions

Example 2 (fig. 7b): How to connect the switch in order to perform the STEP-BY-STEP and one of the auxiliary input functions (PARTIAL OPENING, OPEN ONLY, CLOSE ONLY ...)

Note – For electrical connections with the "Stand By" function active, see "Stand By/Phototest function" in this paragraph 2.4.1.

• Connection for Gate Open Indicator / Electric lock (fig. 8)

If the gate open indicator has been programmed, the output can be used as an open gate indicator light. The light, flashes slowly during opening and quickly during closing; If it is on but does not flash, this indicates that the gate is open. If the light is off, the gate is closed. Se the output has been programmed as an electric lock, it is activated for 3 seconds each time opening begins.

2.4.2 - STOP type input

The MC424 control unit can be programmed for two types of STOP input:

- **NC type STOP** for connecting up to NC type contacts.
- **Constant resistance STOP.** It enables the user to connect up to the control unit of devices with 8.2kΩ constant resistance (e.g. sensitive edges). The input measures the value of the resistance and disables the manoeuvre when the resistance is outside the nominal value. Devices with normally open "NO" or normally closed "NC" contacts, or multiple devices, even of different types, can be connected to the constant resistance STOP input, provided that appropriate adjustments are made; see Table 1.

WARNING! – If the constant resistance STOP input is used to connect devices with safety functions, only the devices with 8.2 KΩ constant will resistance output guarantee the fail-safe category 3.

second device type:	1st device type:		
	NO	NC	8,2 KΩ
	In parallel (note 1)	(note 2)	In parallel
NC	(note 2)	In series (note 3)	In series
8,2KΩ	In parallel	In series	(note 4)

Notes to Table 1:

Note 1 – Any number of NO devices can be connected to each other in parallel, with an 8.2KΩ termination resistance (**fig. 9a**). For electrical connections with the "Stand By" function active, see "Stand By/Phototest function" in this paragraph 2.4.1.

Note 2 – The NO and NC combination can be obtained by placing the two contacts in parallel, and placing an 8.2KΩ resistance in series with the NC contact. It is, therefore, possible to combine 3 devices: NO, NC and 8.2KΩ (**fig. 9b**).

Note 3 – Any number of NC devices can be connected in series to each other and to an 8.2KΩ resistance (**fig. 9c**).

Note 4 – Only one device with an 8.2KΩ constant resistance output can be connected; multiple devices must be connected "in cascade" with a single 8.2KΩ termination resistance (**fig. 9d**).

2.5 - Initial start-up and electrical connections

IMPORTANT! – Connections must be made exclusively by qualified personnel.

After powering up the control unit, check that all the LEDs flash rapidly for a few seconds, then perform the following checks:

1. Check that there is a voltage of approximately 30Vdc on terminals 9-10. If not, unplug the unit immediately and carefully check the connections and input voltage.
2. After initially flashing rapidly, the P1 LED will indicate the control unit is working correctly by flashing regularly at 1 second intervals. When there is a variation in the inputs, the "P1" led will rapidly flash twice to show that the input has been recognised.
3. If the connections are correct, the LED for the "NC"-type inputs will be on, while those for the "NO" type inputs must be off. See **fig. A** and **Table 2**.

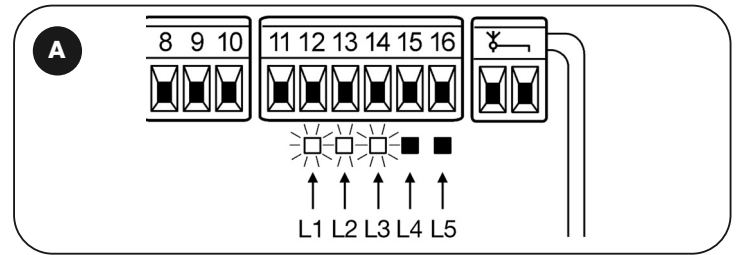

TABLE 2

INPUT	INPUT TYPE	STATUS LED
STOP	STOP NC	L1 On
	CONSTANT RESISTANCE	L1 On
	STOP 8.2 KΩ	L1 On
PHOTO	NC	L2 On
FOTO1	NC	L3 On
STEP-BY-STEP	NO	L4 Off
AUX	OPEN PARTIALLY type 1 - NO	L5 Off
	OPEN PARTIALLY type 2 - NO	L5 Off
	OPEN ONLY - NO	L5 Off
	CLOSE ONLY - NO	L5 Off
	FOTO2 - NC	L5 On

4. Check that the relative LEDs switch on and off when the devices connected to the inputs are operated.
5. Check that by pressing P2 both motors perform a short opening manoeuvre, and the motor of the upper leaf starts first. Block the manoeuvre by pressing P2 again. If the motors do not start up for opening, invert the polarities of the motor cables. If, however, the first one to move is not the upper leaf, operate jumper E (**fig. 2**).

2.6 - Automatic search system for the limit switches

On the successful completion of the various controls, start the automatic search system phase for the limit switches. This work is necessary as the MC424 control unit must "measure" how long the opening and closing manoeuvres take. This procedure is completely automatic and detects the mechanical opening and closing stops by measuring the load on the motors.

Warning! – If this procedure has already been carried out, in order to reactivate it, the user must first delete the memory (see the "Memory deletion" chapter). In order to check whether the memory contains any limit switch parameters, turn the power supply to the control unit on and then off again. If all the LEDs flash rapidly for approximately 6 seconds, the memory is empty. If, however, they only flash for 3 seconds, the memory already contains some limit switch parameters.

Before starting limit switch searching, make sure that all the safety devices are enabled (STOP, PHOTO and PHOTO1). The procedure will be immediately interrupted if a safety device triggers or a command arrives. Ideally the doors should be half open, although they can be in any position.

Procedure – Press the P2 button (fig. 2) to start begin searching which includes:

- Both motors open briefly.
- Motor closes the lower leaf until it reaches the mechanical closing stop.
- The upper leaf motor closes until it reaches the mechanical closing stop.
- The motor of the upper leaf begins to open.
- After the programmed delay, opening of the lower leaf begins. If the delay is insufficient, block the search by pressing P1 (**fig. 2**), then modify the time (see chapter 5).
- The control unit measures the movement required for the motors to reach the opening mechanical stops.
- Complete closing manoeuvre. The motors can start at different times, the aim is to prevent the leaves from shearing by maintaining a suitable delay.
- End of the procedure with memorisation of all measurements.

All these phases must take place one after the other without any interference from the operator. If the procedure does not continue correctly, it must be interrupted with the P1 button. Repeat the procedure, modifying some parameters if necessary, for example the current sensitivity cut-in thresholds (see chapter 5).

3 TESTING AND COMMISSIONING

These are the most important phases of automation set-up for ensuring maximum system safety. The test can also be performed as a periodic check of automation devices. Testing and commissioning of the automation must be performed by skilled and qualified personnel, who are responsible for the tests required to verify the solutions adopted according to the risks present, and for ensuring observance of all legal provisions, standards and regulations, and in particular all requirements of the standard EN 12445, which establishes the test methods for checking automations for doors and gates.

The additional or optional devices must undergo a specific test for functionality and correct interaction with MC424. Refer to the instruction manuals of the individual devices.

3.1 - Testing

The testing sequence refers to the control unit programmed with the preset functions. See paragraph 5.1:

- Make sure that the activation of the STEP-BY-STEP input generates the following sequence of movements: "Open, Stop, Close, Stop".
- Make sure that the activation of the AUX input (Type 1 partial opening function) manages the "Open, Stop, Close, Stop" sequence of the motor of the upper leaf only, while the motor of the lower leaf remains in the closed position.
- Perform an opening manoeuvre and check that:
 - the gate continues the opening manoeuvre when PHOTO is engaged
 - the opening manoeuvre stops when PHOTO1 is engaged and only continues when PHOTO1 is disengaged
 - The manoeuvre stops when PHOTO2 (if installed) is engaged and the closing manoeuvre starts
- Make sure that the motor switches off when the door reaches the mechanical stop.
- Perform an opening manoeuvre and check that:
 - The manoeuvre stops when PHOTO is engaged and the opening manoeuvre starts
 - The manoeuvre stops when PHOTO1 is engaged and the opening manoeuvre starts again when PHOTO1 is disengaged
 - the gate continues the closing manoeuvre when PHOTO 2 is engaged
- Check that the stopping devices connected to the STOP input immediately stop all movement.
- Check that the level of the obstacle detection system is suitable for the application:
 - During both the opening and the closing manoeuvres, prevent the leaf from moving by placing an obstacle and check that the manoeuvre inverts before exceeding the force set down by law
- Other checks may be required depending on which devices are connected to the inputs.

Warning – If an obstacle is detected as moving in the same direction for 2 consecutive manoeuvres in the same direction, the control unit partially inverts both motors for just 1 second. At the following command, the leaves begin the opening manoeuvre and the first current sensitivity cut-in for each motor is considered as a mechanical stop during the opening cycle. The same happens when the mains power supply is switched on: the first command is always an opening manoeuvre and the first obstacle is always considered as a mechanical stop during the opening cycle.

3.2 - Commissioning

Commissioning can only be performed after positive results of all test phases.

- 1 Prepare the automation technical documentation, which must contain the following documents: overall drawing of the automation, electrical wiring diagram, risk assessment and relative solutions adopted (refer to the relevant forms on our website www.niceforyou.com), manufacturer's declaration of conformity for all devices used and installer's declaration of conformity.
- 2 Affix a dataplate on the gate, specifying at least the following data: type of automation, name and address of manufacturer (responsible for commissioning), serial number, year of construction and CE mark.
- 3 Before commissioning the automation, ensure that the owner is adequately informed of all associated risks and hazards.

4 DIAGNOSTICS

The diagnostics LED P2 (**fig. 2**) indicates any problems or malfunctions revealed by the control unit during the manoeuvre.

A sequence with a certain number of flashes indicates the type of problem and remains active until the following manoeuvre begins. The table below summarises this information:

Number Led P2 flashes	Type of malfunction
1	M1 current sensitivity device triggering
2	M2 current sensitivity device triggering
3	STOP input cut-in during the manoeuvre
4	Phototest error
5	Output overcurrent gate open indicator or electric lock

5 PROGRAMMING

The MC424 control unit features some programmable functions. These functions are pre-set in a typical configuration which satisfies most automatic systems. These functions can be changed at any time, both before and after searching automatically for limit switches, by carrying out the relevant programming procedure; see paragraph 5.3.

5.1 - Preset functions

- Motor movement: fast
- Automatic closing: enabled
- Condominium function: disabled
- Pre-flashing: disabled
- Close after photo: disabled
- Opening delay: level 2 (10%)
- STAND BY / Phototest: Stand by
- Gate open indicator/Electric Lock: Gate open indicator
- STOP input: NC type
- Heavy gates: disabled
- Proportional gate open indicator: disabled
- Pause time: 20 seconds
- Auxiliary input: type 1 partial opening (only the upper leaf motor is activated)
- Current sensitivity: Level 2

5.2 - Programmable functions

To ensure the system is best suited to the user's requirements, and safe in the various different conditions of use, the MC424 control unit offers the possibility to programme several functions or parameters, as well as the function of a number of inputs and outputs.

5.2.1 - Direct programming

- **Slow/rapid movement:** The user can choose the speed of movement of the gate, at any time (with the motor arrested) simply by operating the P3 key (**fig. 2**) at any time the control unit is not being programmed. If LED L3 is off, this shows that the slow movement has been set, if on the fast one has.

5.2.2 - Level one programming: part one

- **Automatic closing:** This function features an automatic closing cycle after the programmed pause time; the pause time is factory set to 20 seconds but it can be modified to 5, 10, 20, 40 or 80 seconds.
If the function is not activated, the system will run "semi-automatically".
- **"Condominium" function:** This function is useful when the automatic system is radio-commanded by many different people. If this function is active, each command received triggers an opening manoeuvre that cannot be interrupted by further commands. If the function has been deactivated, a command causes: OPEN-STOP-CLOSE-STOP.
- **Pre-flashing:** This function activates the flashing light before the manoeuvre begins for a time that can be programmed to 3 seconds.
If the function is disabled, the light will start flashing when the manoeuvre starts.
- **Close after photo:** During the automatic closing cycle, this function reduces the pause time to 4 seconds after the PHOTO photocell has disengaged, i.e. the gate closes 4 seconds after the user has passed through it. If the function is disabled, the whole programmed pause time will pass.
- **Opening delay:** During opening, this function causes a delay in the activation

of the lower leaf motor compared with the upper one. This is necessary in order to prevent the leaves from getting stuck. There is always a standard delay during closing, calculated automatically by the control unit in order to ensure the same delay as the one programmed for opening.

5.2.3 - Level one programming: part two

- **Stand By / Phototest function:** The control unit has the "Stand-by" function preset. If this function is active, 1 minute after the end of a manoeuvre the control unit turns off the "Stand-by" output (terminal no. 8) and all the Inputs and other Outputs to reduce consumptions (see electrical diagram in fig. 5a). This function is obligatory if the control unit is powered exclusively with Solemyo photovoltaic panels. It is also recommended if the control panel is powered from the electric mains and if you wish to extend emergency operation with the buffer battery PS124. As an alternative to the "Stand-by" function, the "Phototest" function may be activated. This verifies at the beginning of a manoeuvre that the connected photocells operate correctly. To use this function, connect the photocells correctly (see electrical diagram in fig. 5c) and then activate the function.
- **Open gate indicator light / electric lock:** If the function is activated, terminals 6-7 can be used to connect up the electric lock. If the function is deactivated, terminals 6-7 can be used to connect up a 24V gate open indicator.
- **NC Type or Constant Resistance STOP Input:** If the function is activated, the STOP input is set to "8.2KΩ Constant Resistance". In this case, there must be a 8.2KΩ +/-25% resistance between the common and the input to enable the operation. If the function is not set, the configuration of the STOP input will enable it to function with NC type contacts.
- **Light/heavy gates :** If the function is activated, the control unit enables the user to manage heavy gates, setting the acceleration ramps and slowdown speeds during closing differently. If the function is deactivated, the control unit will be set to manage light gates.
- **Proportional gate open indicator:** If the function is activated, the gate open indicator output will be set with the proportional flashing light. This means that during opening, the flashing becomes more intense as the leaves come nearer to the opening stops; vice-versa, for closing, the flashing becomes less intense as the leaves come nearer to the closing stops. If the function is deactivated, the light will flash slowly during opening and rapidly during closing.

5.2.4 - Level two functions

- **Pause time:** The pause time, namely the time which lapses between opening and closing during automatic functioning, can be programmed to 5, 10, 20, 40, and 80 seconds.
- **Auxiliary input AUX:** The control unit offers an auxiliary input which can be set to carry out one of the following 6 functions:
 - **Partial opening type 1:** this carries out the same function as the STEP-BY-STEP input. It causes only the upper leaf to open. It only works if the gate is closed completely, otherwise the command is interpreted as if it were a STEP-BY-STEP command.
 - **Partial opening type 2:** this carries out the same function as the STEP-BY-STEP input. It causes the two leaves to open for half the time it would take them to open completely, otherwise the command is interpreted as if it were a STEP-BY-STEP command.
 - **Open only:** this input only causes opening in the Open-Stop-Open-Stop sequence.
 - **Close only:** this input only causes closing in the Open-Stop-Open-Stop sequence.
 - **Photo 2:** this carries out the function of the "PHOTO 2" safety device.
 - **Disabled:** the input will not carry out any function
- **Discharge time:** At the end of the Closing manoeuvre, after the leaves have reached the totally closed position, the motor continues to "push" the leaf for a brief interval, to ensure perfect closure. Immediately afterwards, this function activates a very brief inversion of movement to reduce excessive pressure exerted by the motor on the leaves.
- **Current sensitivity:** The control unit is equipped with a system which measures the current absorbed by the two motors used to detect the mechanical stops and any obstacles when the gate is moving. Since the current absorbed depends on a number of conditions, including the weight of the gate, friction, wind and variations in voltage, the cut-in threshold can be changed. There are 6 levels: 1 is the most sensitive (minimum force), 6 is the least sensitive (maximum force).

WARNING! – If the "current sensitivity" function (together with other vital features) is adjusted correctly, the system will comply with European standards, EN 12453 and EN 12445, which require techniques or devices to be used to limit force and danger during the functioning of automatic gates and doors are moved.
- **Leaf delay:** The delay in starting up the motor of the lower leaf can be programmed to 5, 10, 20, 30 or 40% of the working time.

5.3 - Programming

All the functions described in paragraph 5.2 "Programmable functions" chapter can be selected by means of a programming phase which terminates by memorising the choices made. The control unit therefore has a memory which stores the functions and parameters relative to the automation process.

The P1, P2 and P3 buttons are used for all the programming phases, while the 5 LEDs (L1, L2...L5) indicate the selected parameter.

There are two different programming levels:

- At **level 1**, the functions can be enabled or disabled. Each Led (L1, L2...L5) corresponds to a function: if the Led is on, the function is active; if it is off, it is deactivated.

Level one consists in 2 parts which can be selected using the P3 button. The corresponding LED P3 indicates which of the 2 parts has been selected.

Level one (P1 Led lit): part one (P3 Led off)				
L1 Led	L2 Led	L3 Led	L4 Led	L5 Led
Closing Automatic	Function Condominium	Pre-flash	Close after photo	Delay in opening

Level one (P1 Led lit): part two (P3 Led lit)				
L1 Led	L2 Led	L3 Led	L4 Led	L5 Led
Stand By / Phototest	Electric lock	Resistance stop	Heavy gates	Gate open proportional

- It is possible to pass to the **second level** from level one of part one. At this second level the user can choose the parameter relating to the function. A different value corresponds to each LED which must be associated to the parameter.

Level one (P1 Led lit): part one (led P3 off)				
L1 Led	L2 Led	L3 Led	L4 Led	L5 Led
Closing automatic	Function condominium	Pre-flashing	Close after photo	Delay in opening

Level two:				
Parameter:	Parameter:	Parameter:	Parameter:	Parameter:
Time pause	AUX input	Time discharge	Current sensitivity	Leaf delay
L1: 5s	L1: Open partial TYPE 1	L1: no discharge	L1: Level 1 (more sensitive)	L1: 5% s
L2: 10s	L2: Open partial TYPE 2	L2: 0.3s	L2: Level 2	L2: 10%
L3: 20s	L3: Open Only	L3: 0.7s	L3: Level 3	L3: 20%
L4: 40s	L4: Close Only	L4: 1.3s	L4: Level 4	L4: 30%
L5: 80s	L5: Photo 2	L5: 2s	L5: Level 5 (less sensitive)	L5: 40%
	All LEDs off: input not used		All LEDs off: Level 6 (max current sensitività)	

Level one (P1 Led lit): part two (P3 Led lit)				
L1 Led	L2 Led	L3 Led	L4 Led	L5 Led
Stand By / Phototest	Electric lock	Resistance stop	Heavy gates	Gate open proportional

5.3.1 - Level one programming: functions

At level 1, the functions can be enabled or disabled. At level one, LED P1 is always on; if LEDs L1, L2...L5 are on, the functions are activated; if the LEDs are off, the functions are deactivated. A flashing LED indicates which function

has been selected, short flashes indicate the function has been deactivated; long flashes indicate the function has been activated. Press P3 to pass from part one programming to part two programming, and vice-versa.

TABLE A1 - Entering level one programming

01. Press and hold down buttons P1 and P2 for at least 3 seconds
The programming mode has been entered if all the Leds start flashing quickly

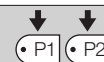

TABLE A2 - Activating or deactivating a function

01. Press P1 repeatedly until the flashing Led reaches the function required



02. Press P1 repeatedly until the flashing Led reaches the function required



TABLE A3 - To pass from part one to part two of level one (and vice-versa)

01. Press P3. button



TABLE A4 - To exit level one and save the modifications

01. Press P1 and then immediately P2, holding them both down for at least 3 seconds

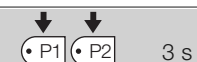
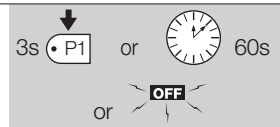

TABLE A5 - Exiting level one and delete the modifications

01. Either press P1 for at least 3 seconds, or wait for 1 minute, or disconnect the power supply



5.3.2 - Level two programming: parameters

The function parameter can be chosen at level two. Level two can only be

reached from level one. At level 2 the P1 Led flashes quickly while the 5 Leds (L1, L2...L5) indicate the selected parameter.

TABLE B1 - Entering level two programming

01. Enter level one programming by pressing P1 and P2 for at least 3 seconds



02. Select the function by pressing P1 until the flashing Led reaches the point required



03. Enter level two by pressing the P2 button for at least 3 seconds

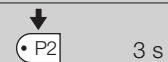

TABLE B2 - Selecting the parameter

01. Press P2 repeatedly until the Led reaches the desired parameter



TABLE B3 - Returning to level one

01. Press P1



TABLE B4 - Exiting level one and saving modifications

01. Press P1 and then immediately P2, holding them both down for at least 3 seconds



TABLE B5 - Exiting level one and cancelling modifications

01. Either press P1 for at least 3 seconds, or wait for 1 minute, or disconnect the power supply

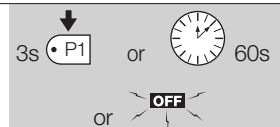



5.3.3 - Memory deletion

Each new programme replaces the previous settings. It is usually unnecessary to "delete all" the parameters". If required, the memory can be totally deleted by

performing this simple operation: **WARNING** – As all the functions return to their pre-set values after the memory is deleted, a new search for the limit switches must be carried out.

TABLE C1 - Delete memory

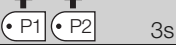
01. Switch the power supply to the control box off, and wait until all the LEDs have gone off (remove fuse F1 if necessary)	
02. Press P1 and P2 on the board down and keep them pressed down	
03. Switch the power supply on again	
04. Wait at least 3 seconds before releasing the two keys	







If the memory was deleted correctly, all the Leds will switch off for 1 second

5.3.4 - Example of level one programming

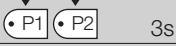
The following examples show how to activate or deactivate a level one function,

the “Condominium” function, for example, and prepare the “Gate Open Indicator” output in order to activate the electric lock.

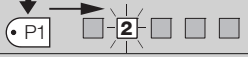
**Example of level one programming:
activate the “Condominium” function and “Electric lock” output**

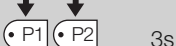



01. Access the level one programming mode by pressing P1 and P2, and keeping them pressed down for at least 3 seconds	
02. Press P1 once to move the flashing Led to the Led 2 (the flashes will be short)	
03. Activate the “Condominium” function by pressing P2 (the flashes will be longer)	
04. Press P3 once in order to activate part two (the P3 LED will switch on)	
05. Press P1 once to move the flashing Led to the Led 2 (the flashes will be short)	
06. Activate the “Electric lock” output by pressing P2 (the flashes will be longer)	
07. Exit programming (with memorisation) by pressing P1 and then immediately P2, holding them both down for at least 3 seconds	

5.3.5 - Example of level two programming

This example shows how to modify a level two parameter, for example, how to

modify current sensitivity until “level 5”.

Example of level two programming: modifying “current sensitivity”

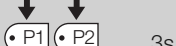
01. Access the level one programming mode by pressing P1 and P2 for at least 3 seconds	
02. Press P1 three times to move the flashing Led to the Led 4	
03. Access level two by pressing P2 for at least 3 seconds	
04. Press P2 three times until Led 5 switches on	
05. Return to level one by pressing P1	
06. Exit programming (with memorisation) by pressing P1 and then immediately P2, holding them both down for at least 3 seconds	

Errata corrige

MC424

Nice

IST280B.4858 Rev. 00 15-04-2010

EN Paragraph 5.3.3 – Deleting the memory: replace Table C1 with the following

TABLE C1 - Delete memory

01. Switch the power supply to the control box off, and wait until all the LEDs have gone off (remove fuse F1 if necessary)	
02. Press P1 and P2 on the board down and keep them pressed down	
03. Switch the power supply on again	
04. Press and hold the two keys for 3 seconds and release <u>as soon as this interval elapses</u>	

If the memory was deleted correctly, all the Leds will switch off for 1 second; if the leds continue to flash, the entire memory deletion procedure must be repeated.

IT Paragrafo 5.3.3 - Cancellazione memoria: sostituire la Tabella C1 con la seguente

TABELLA C1 - Per cancellare la memoria

01. Spegner l'alimentazione alla centrale ed aspettare che tutti i LED siano spenti (eventualmente togliere il fusibile F1)	
02. Premere e tenere premuti i due tasti P1 e P2 sulla scheda	
03. Ridare alimentazione alla centrale	
04. Tenere premuti i due tasti per 3 secondi e rilasciarli <u>appena scaduto questo tempo</u>	

Se la cancellazione della memoria è andata a buon fine, tutti il led si spengono per 1 secondo; se i led continuano a lampeggiare, occorre ripetere tutta la procedura di cancellazione della memoria.



FR Paragraphe 5.3.3 - Effacement mémoire : remplacer le Tableau C1 par le suivant

TABLEAU C1 - Pour effacer la mémoire

01. Éteindre l'alimentation de la logique de commande et attendre que toutes les leds soient éteintes (éventuellement enlever le fusible F1)	
02. Presser et maintenir enfoncées les deux touches P1 et P2 sur la carte électronique	
03. Remettre la logique sous tension	
04. Maintenir les deux touches enfoncées pendant 3 secondes et les relâcher <u>dès que ce temps se sera écoulé</u>	

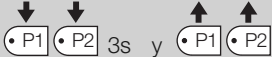

Si l'effacement de la mémoire a été effectué correctement, toutes les leds s'éteignent pendant 1 seconde ; si les leds continuent à clignoter, il faut répéter toute la procédure d'effacement de la mémoire.

TABLA C1 - Para borrar la memoria

01. Apague la alimentación de la central y espere que todos los LEDs estén apagados (de ser necesario quite el fusible F1)	
02. Pulse y mantenga pulsados los dos botones P1 P2 en la tarjeta	
03. Active de nuevo la alimentación de la central	
04. Mantenga oprimidos los dos pulsadores durante 3 segundos y suéltelos <u>ni bien concluya este lapso de tiempo</u>	

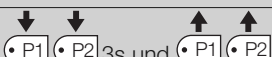

Si la memoria se hubiera borrado correctamente, todos los leds se apagarán durante un segundo; si los leds siguen destellando, habrá que repetir todo el procedimiento de borrado de la memoria.

TABELLE C1 - Löschen des Speichers

01. Die Stromversorgung zur Steuerung abschalten und warten, dass alle LEDs ausgeschaltet sind (ggf. die Sicherung F1 entfernen)	
02. Die beiden Tasten P1 P2 auf der Steuerkarte drücken und gedrückt halten	
03. Die Stromversorgung zur Steuerung wieder einschalten	
04. Die beiden Tasten 3 Sekunden lang drücken und <u>nach dieser Zeitspanne freigeben</u>	

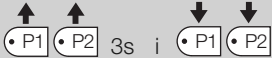

Falls das Löschen des Speichers erfolgreich war, werden sich alle LEDs 1 Sekunde lang ausschalten, wenn die Leds weiterhin blinken, muss das ganze Speicherlöschverfahren wiederholt werden.

TABELA C1 - Aby skasować pamięć

01. Odłącz zasilanie od centrali i odczekaj, aż wszystkie DIODY zgasną (ewentualnie wyjmij bezpiecznik F1)	
02. Wciśnij i przytrzymaj oba przyciski P1 P2 znajdujące się w centrali	
03. Ponownie podłącz zasilanie do centrali	
04. Przytrzymaj wciśnięte oba przyciski przez 3 sekundy, następnie <u>zwolnij je po upływie tego czasu</u>	

Jeżeli kasowanie pamięci zostało wykonane prawidłowo, wszystkie diody zgasną na 1 sekundę; jeżeli diody nadal migają należy powtórzyć całą procedurę kasowania pamięci.

TABEL C1 - Wissen van het geheugen

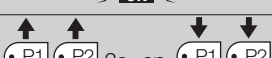
01. Schakel de stroomvoorziening naar de besturingseenheid uit en wacht totdat alle LEDs uit zijn (verwijder eventueel de zekering F1)	
02. Druk op de twee toetsen P1 P2 op de kaart en houd die ingedrukt	
03. Schakel de stroomvoorziening naar de besturingseenheid weer in	
04. Houd de twee toetsen 3 seconden ingedrukt en laat ze los <u>zo gauw deze tijd verstreken is</u>	

Als het wissen van het geheugen tot een goed einde is gekomen, gaan alle leds 1 seconde uit; als de led's blijven knipperen, dient u de hele procedure voor wissen van het geheugen te herhalen.

5.3.6 - Programming diagram

The following figure shows the complete programming diagram of the functions and relative parameters.

This figure also shows the functions and parameters either as they were initially or following total memory deletion.

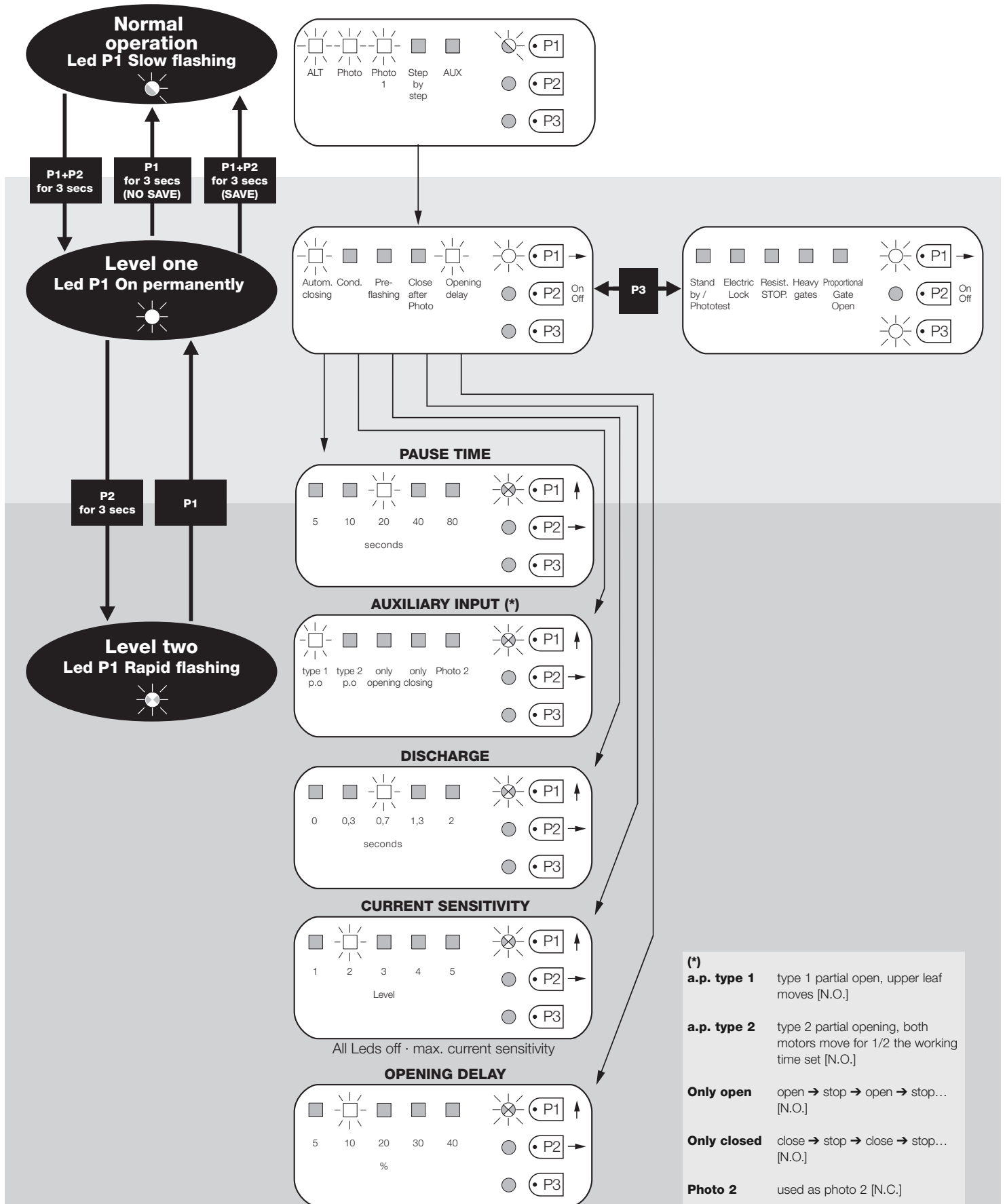

6 FURTHER DETAILS: accessories

6.1 - Connecting a radio receiver

The control unit has a connector for fitting a 4 channel radio card complete with SM slot. This remote control device functions by means of transmitters which act on the inputs as per the following table:

Output Receiver	Control unit input
N° 1	Step by step
N° 2	AUX (reset value: Partially Open 1)
N° 3	"Open only"
N° 4	"Close only"

6.2 - Connecting model PS124 buffer battery

PS124 buffer batteries can be used to supply the control unit in case of network blackouts. To install and connect the battery, proceed as shown in **fig. 10**.

6.3 - Connecting the Solemyo system

The control unit is designed to be powered with the "Solemyo" photovoltaic system (photovoltaic panel and 24 V battery). To connect the Solemyo battery to the control unit, use the socket on the control unit that is normally used for the buffer battery (see paragraph 6.2).

IMPORTANT!

- When the automation is powered by the "Solemyo" system, it **MUST NOT BE POWERED** at the same time from the electrical mains.

- The Solemyo system can be used only if the Standby function on the control unit is ON and the connections are as shown in the diagram in **fig. 5a**.

7 TROUBLESHOOTING (troubleshooting guide)

No LEDs are on:

- Check whether the control unit is powered (measure a voltage of about 30Vdc at terminals 9-10 (or 24 Vdc with battery power).
- Check the 2 fuses, if not even the P1 Led is on or flashing a serious fault has probably occurred and the control unit must therefore be replaced.

The P1 LED flashes regularly but the input LED's L1, L2...L5 do not reflect the state of the respective inputs

- Switch the unit off for the moment in order to exit a possible programming phase.
- Carefully check the connections on terminals 11 to 16.

LED P1 flashes every 4 seconds

- The control unit is in Stand by status.

The "Automatic search" procedure does not start up

- The "Automatic search" procedure only starts if it has never been performed before or if the memory has been deleted. To check whether the memory is empty switch off the unit for a moment. When it is switched on again, all the Leds should flash rapidly for about 6 seconds. If they only flash for 3 seconds, the memory already contains valid values. If a new "Automatic search" is required, the memory must be completely deleted.

The "Automatic search" procedure has never been performed but it either does not start or it behaves incorrectly

- The system and all the safety devices must be operative in order to activate the "Automatic search" procedure.
- Make sure that no device connected to the inputs cuts in during the "Automatic search" procedure.
- In order for the "Automatic search" procedure to start correctly, the input Leds must be on as shown in **fig. 11**, the P1 Led must flash once a second.

The "Automatic search" procedure was performed correctly but the manoeuvre does not start

- Check that the safety device (STOP, PHOTO, PHOTO1 and, if installed, PHOTO2) Leds are on and that the relative command Led (STEP-BY-STEP or AUX) remains on for the entire duration of the command.
- If the "Phototest" function is activated but the photocells do not function correctly, the DIAGNOSTICS LED indicates the fault by flashing four times.

The gate inverts the direction while moving

An inversion is caused by:

- The photocells triggering (PHOTO2 during the opening manoeuvre, PHOTO or PHOTO1 during the closing manoeuvre). In this case, check the photocell connections and input LEDs.
- The current sensitivity device triggers while the motors are moving (not near

the mechanical stops, therefore). This is considered as an obstacle and causes an inversion. To find out if the current sensitivity device has triggered, count how many times the Diagnostics LED flashes: 1 flash indicates that the current sensitivity device triggered on account of motor 1, 2 flashes indicate that this was caused by motor 2.

8 PRODUCT MAINTENANCE

As the MC424 control unit is electronic it requires no particular maintenance. However, at least every six months the efficiency of the entire system must be checked according to the information described in chapter 3.

DISPOSAL OF THE PRODUCT

This product is an integral part of the automation, and therefore, they must be disposed of together.

As for the installation operations, at the end of the life of this product, the dismantling operations must be performed by qualified personnel.

This product is made from different types of materials: some can be recycled, others must be disposed of. Please inform yourselves on the recycling or disposal systems provided for by the laws in force in your area, for this category of product.

CAUTION! – some parts of the product can contain polluting or dangerous substances which, if dispersed in the environment, may cause serious harm to the environment and human health.

As indicated by the symbol at the side, it is forbidden to throw this product into domestic refuse. Therefore, follow the "separated collection" instructions for disposal, according to the methods provided for by local regulations in force, or redeliver the product to the retailer at the moment of purchase of a new, equivalent product.



CAUTION! – the regulations in force at local level may envisage heavy sanctions in case of abusive disposal of this product.

TECHNICAL CHARACTERISTICS OF THE PRODUCT

WARNINGS: • All technical characteristics stated refer to an ambient temperature of 20°C (±5°C). • Nice S.p.a reserves the right to modify the product at any time, while maintaining the same functionalities and intended use.

Mains power supply	MC424 Control units: 230 V~ ±10% 50 ÷ 60 Hz MC424/V1 Control units: 120 V~ ±10% 50 ÷ 60 Hz
Max absorbed power	170 W
Emergency power supply	for PS124 buffer batteries and for Solemyo solar kit
Maximum motor current:	3A (with a "level 6" current sensitivity cut in)
Service power output	24 V --- 200 mA maximum current (the voltage can vary from 16 to 33 V ---)
Phototest Output	24 V --- 100 mA maximum current (the voltage can vary from 16 to 33 V ---)
Flashing lamp output	for flashing lamp 24 V ---, maximum power 25 W (the voltage can vary from 16 to 33 V ---)
Gate open indicator output	for indicator lamps at 24 V --- maximum power 5 W (the voltage can vary from 16 to 33V ---) or electric locks 12 V~ 25 W
STOP Input	for NC contacts or constant resistance 8,2 KΩ +/- 25%
Working time	automatic detection
Pause time	programmable at 5, 10, 20, 40, 80 seconds
Discharge time	programmable to 0, 0.3, 0.7, 1.3, 2 seconds
Leaf delay in open cycle	programmable at 5, 10, 20, 30 and 40 % of working time
Leaf delay in close cycle	automatic detection
1st motor output	for Wingo WG4024 - WG5024
2nd motor output	for Wingo WG4024 - WG5024
Max. cable length	230 V power supply 30 m Solemyo solar power kit 3 m motors 10 m other inputs/outputs 30 m flashing light 10 m SCA 30 m electric lock 10 m aerial 20 m (recommended less than 3 m)
Radio receiver	"SM" type coupling for receivers SMXI, SMXIS, OXI (Mode I and Mode II)
Temperatura di esercizio	from - 20 to 50 °C
Protection rating	IP 54 with enclosure intact
Dimensions (mm)	310 x 232 x H 122
Weight (kg)	4,1

EC DECLARATION OF CONFORMITY

Note - The contents of this declaration correspond to declarations in the last revision of the official document deposited at the registered offices of Nice Spa available before this manual was printed. The text herein has been re-edited for editorial purposes.

Number: 296/MC424

Revision: 0

The undersigned, Lauro Buoro, in the role of Managing Director, declares under his sole responsibility, that the product:

Manufacturer's Name: NICE s.p.a.

Address: Via Pezza Alta 13, Z.I. Rustignè, 31046 Oderzo (TV) Italy

Type: Two 24 Vdc motor control unit

Models: MC424

Accessories: SMXI, SMXIS radio receiver

conform with the requirements of the following EC directives:

- 98/37/EC (89/392/EEC amended); DIRECTIVE 98/37/EC OF THE EUROPEAN PARLIAMENT AND COUNCIL of 22 June 1998 regarding the approximation of member state legislation relating to machinery.
As established in directive 98/37/EC, the above-mentioned product may not be started up unless the machine in which the product is incorporated has been identified and declared as conforming to directive 98/37/EC.

The product also complies with the requirements of the following EC directives:

- 2006/95/EEC (ex directive 73/23/EEC); DIRECTIVE 2006/95/EEC OF THE EUROPEAN PARLIAMENT AND COUNCIL of 12 December 2006 regarding the approximation of member state legislation relating to electrical material intended for use within specific voltage limits
According to the following harmonised standards: EN 60335-1:1994+A11:1995+A1:1996+A12:1996+A13:1998+A14:1998+A15:2000+A2:2000+A16:2001
- 2004/108/EEC (ex directive 89/336/EEC); DIRECTIVE 2004/108/EEC OF THE EUROPEAN PARLIAMENT AND COUNCIL of 15 December 2004 regarding the approximation of member state legislation relating to electromagnetic compatibility, repealing directive 89/336/EEC
According to the following harmonised standards: EN 61000-6-2:2001; EN 61000-6-3:2001+A11:2004

The product also complies, within the constraints of applicable parts, with the following standards:

EN 60335-1:2002+A1:2004+A11:2004+A12:2006+ A2:2006, EN 60335-2-103:2003, EN 13241-1:2003; EN 12453:2002; EN 12445:2002; EN 12978:2003

Oderzo, 25 September 2008

Lauro Buoro (Managing Director)



1 PRODUCT DESCRIPTION

SMXI and SMXIS are 4-channel radio receivers for control units equipped with SM-type connector. The peculiarity of compatible transmitters is that the identification code is different for each transmitter. Therefore, in order to allow the receiver to recognise a determined transmitter, the recognition code must be memorised. This operation must be repeated for each transmitter required to communicate with the control unit.

Notes:

- Up to a maximum of 256 transmitters can be memorised in the receiver. No one transmitter can be cancelled; all the codes must be deleted
- For more advanced functions use the appropriate programming unit.

The receiver features 4 outputs, all available on the underlying connector. To find out which function is performed by each output, see chapter 6.1.

During the transmitter code memorisation phase, one of these two options may be chosen:

Mode I - Table B1: Each transmitter button activates the corresponding output in the receiver, that is, button 1 activates output 1, button 2 activates output 2, and so on. In this case there is a single memorisation phase for each transmitter; during this phase, it doesn't matter which button is pressed and just one memory sector is occupied.

Mode II - Table B2: Each transmitter button can be associated with a particular output in the receiver, e.g., button 1 activates output 2, button 2 activates output 1, and so on. In this case, the transmitter must be memorised, pressing the required button, for each output to activate. Naturally, each button can activate just one output while the same output can be activated by more than one button. One memory section is occupied for each button.

TABLE B1 - Mode I memorising (All buttons are memorised on the related receiver output)









01. Press and hold down the receiver button for at least 3 seconds		3s
02. Release the button when the Led lights up		
03. Push, for at least 2 seconds, any of the buttons of the transmitter to be memorised within 10 seconds		2s
<i>Note – If the procedure was memorised correctly, the Led on the receiver will flash 3 times. If there are other transmitters to memorise, repeat step 3 within another 10 seconds. The memorisation phase finishes if no new codes are received for 10 seconds.</i>		x3

TABLE B2 - Mode II memorising (A specific receiver output can be associated to each button)

01. Press and release the receiver button as many times as the number of the desired output (Once for output No. 1, twice for output No. 2)		
02. Check that the LED emits the same number of flashes as the desired output, repeated over 10 seconds in regular intervals (1 flash if output No. 1, 2 flashes if output No. 2)		
03. Within 10 seconds press the desired button on the transmitter to be memorised, holding it down for at least 2 seconds.		2s
<i>Note – If the procedure was memorised correctly, the Led on the receiver will flash 3 times. If there are other transmitters to memorise, repeat step 3 within another 10 seconds. The memorisation phase finishes if no new codes are received for 10 seconds.</i>		x3

2 INSTALLING THE AERIAL

The receiver requires an ABF or ABFKIT type aerial to work properly; without an aerial the range is limited to just a few metres. The aerial must be installed as high as possible; if there are metal or reinforced concrete structures nearby you can install the aerial on top. If the cable supplied with the aerial is too short, use a coaxial cable with 50-Ohm impedance (e.g. low dispersion RG58), the cable must be no longer than 10 m.

If the aerial is installed in a place that is not connected to earth (masonry structures), the braid's terminal can be earthed to provide a larger range of action. The earth point must, of course, be local and of good quality. If an ABF or ABFKIT aerial cannot be installed, you can get quite good results using the length of wire supplied with the receiver as the aerial, laying it flat.

3 MEMORISING A REMOTE CONTROL

WARNING – When the memorisation phase is activated, any transmitter correctly recognised within the reception range of the radio is memorised. Consider this aspect with care and remove the aerial if necessary to reduce the capacity of the receiver.

The procedures for memorising the remote controls must be performed within a certain time limit; please read and understand the whole procedure before starting.

In order to carry out the following procedure, it is necessary to use the button located on the box of the radio receiver (reference **A**, Fig. 1a), and the corresponding LED (reference **B**, Fig. 1a) to the left of the button.

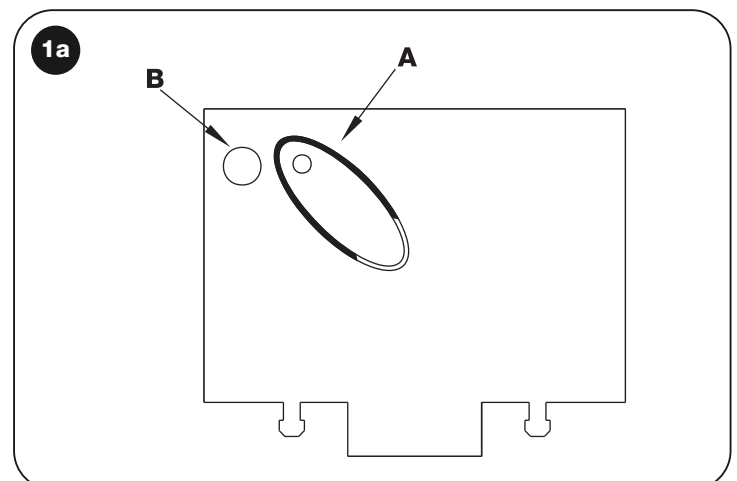







Remote memorising

It is possible to enter a new transmitter in the receiver memory without using the keypad. A previously memorised and operational remote control must be available. The new transmitter will "inherit" the characteristics of the previously memorised one. Therefore, if the first transmitter is memorised in mode I, the new one will also be memorised in mode I and any of the buttons of the transmitter can be pressed. If the first transmitter is memorised in mode II the new one will also be memorised in mode II but the button activating the required

output must be pressed on the first transmitter as must the button required to be memorised on the second. You need to read all the instructions in advance so you can perform the operations in sequence without interruptions. Now, with the two remote controls (the NEW one requiring code memorisation and the OLD one that is already memorised), position yourself within the operating range of the radio controls (within maximum range) and carry out the instructions listed in the table.

TABLE B3 - Remote Memorising





01. Press the button on the NEW transmitter for at least 5 seconds and then release	 x5s 
02. Press the button on the OLD transmitter 3 times slowly	 1s  1s  1s
03. Press the button on the NEW transmitter slowly and then release	 x1

Note – If there are other transmitters to memorise, repeat the above steps for each new transmitter.

4 DELETING ALL TRANSMITTERS

All the memorised codes can be deleted as follows:

TABLE B4 - Deleting all transmitters

01. Press the receiver button and hold it down	
02. Wait for the Led to light up, then wait for it to switch off and then wait for it to flash 3 times	  x3
03. Release the button exactly during the third flash	  3°

Note – if the procedure was performed correctly, the Led will flash 5 times after a few moments.

TECHNICAL CHARACTERISTICS OF THE PRODUCT

WARNINGS: • All technical characteristics stated refer to an ambient temperature of 20°C (±5°C). • Nice S.p.a reserves the right to modify the product at any time, while maintaining the same functionalities and intended use. • The range of the transmitters and the reception capacity of the receivers may be subject to interference that may alter their performance. In the event of interference, Nice cannot guarantee the effective capacity of their devices.

Receivers:	SMXI	SMXIS
Decoding	Rolling code 52 bit FLOR	Rolling code 64 bit SMILO
Transmitter compatibility	FLOR, VERY VR, NICE WAY, ERGO, PLANO, NICE ONE	SMILO
Frequency	433.92 MHz	433.92 MHz
Input impedance	52 KΩ	52 KΩ
Outputs	4 (on SM connector)	4 (on SM connector)
Sensitivity	better than 0.5 μV	better than 0.5 μV
Working temp.	from -10°C to + 55° C	from -10°C to + 55° C

Transmitters:	FLO2R	SMILO
Buttons	1, 2 or 4 according to the versions	2 or 4
Power input	12 V--- Batt. 23 A	12 V--- Batt. 23 A
Absorption	10 mA	25 mA
Transmission frequency	433.92 MHz	433.92 MHz
Working temp.	from -10°C to + 55° C	from -10°C to + 55° C
Radiated power	estimated approximately 1 mW E.R.P.	estimated approximately 1 mW E.R.P.
Range	estimated 200 m (outdoors); 35 m (indoors)	estimated 200 m (outdoors); 35 m (indoors)
Dimensions / Weight	69 x 39 x 15,5 mm / 31 g.	∅ 48 mm x H 14 mm - 14 g
Encoding	digital (4.5 x 10 ¹⁵ combinations)	digital (18 x 10 ¹⁵ combinations)

EN - Images

IT - Immagini

FR - Images

ES - Imágenes

DE - Bilder

PL - Zdjęcia

NL - Afbeeldingen

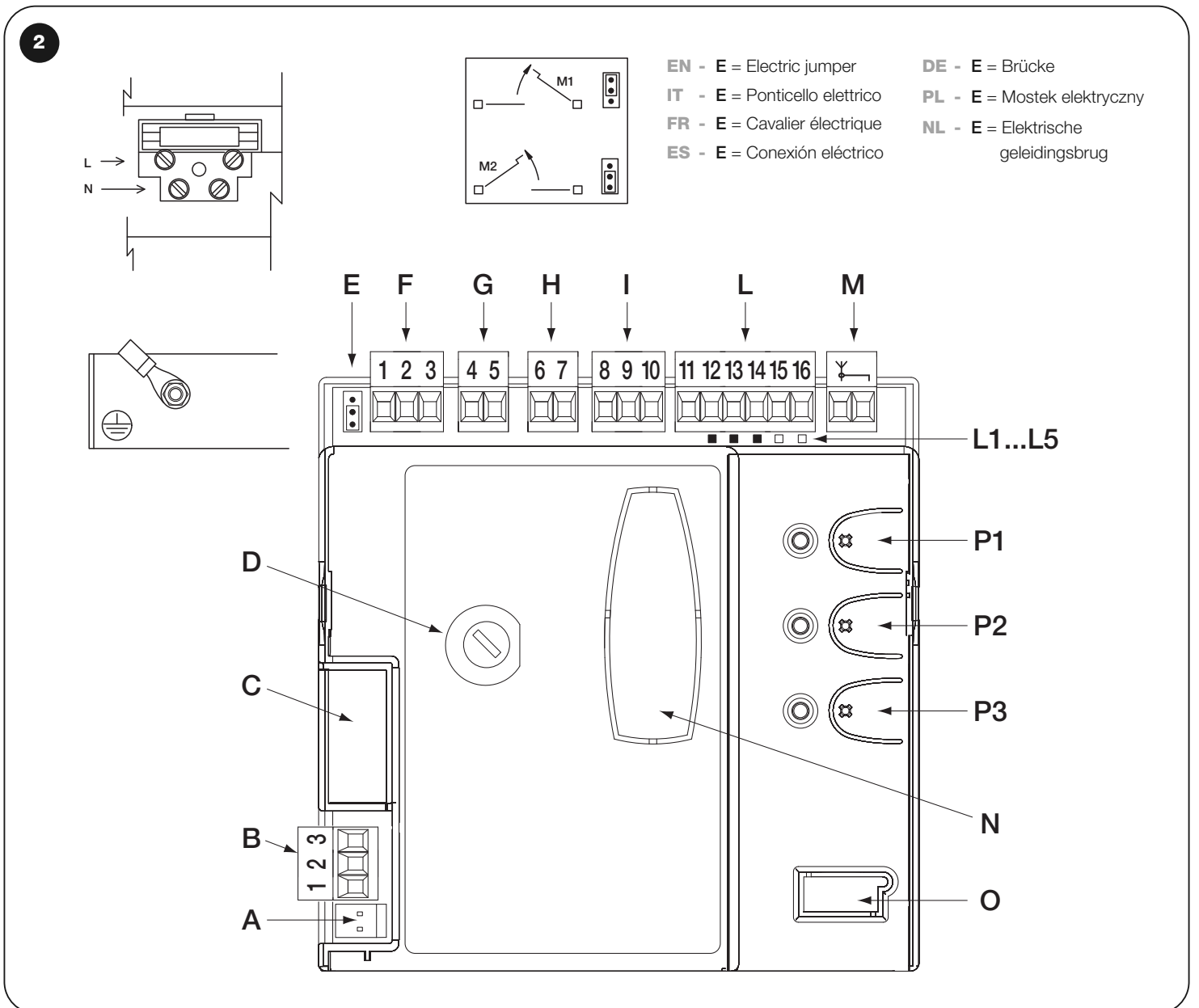
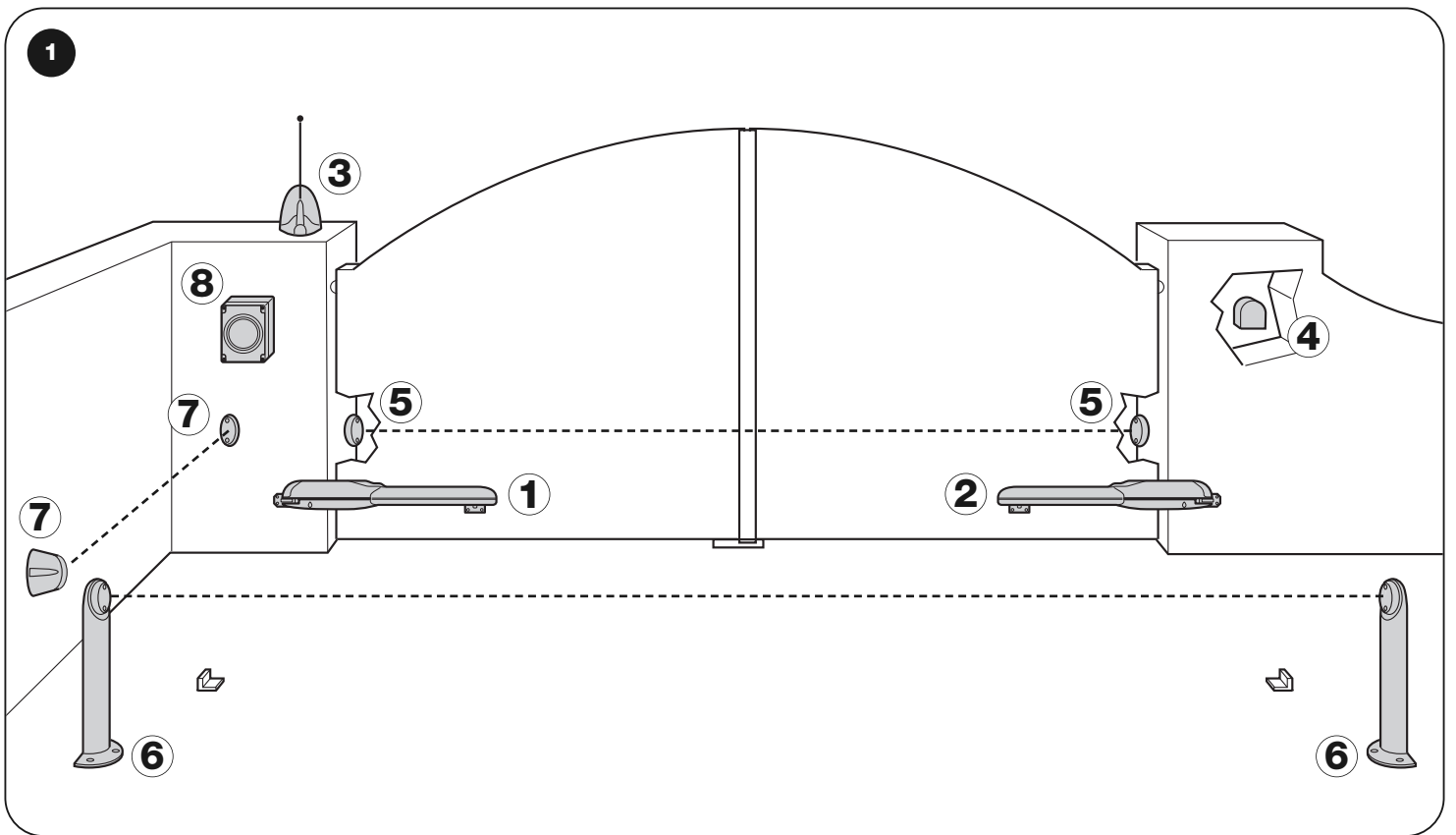

3

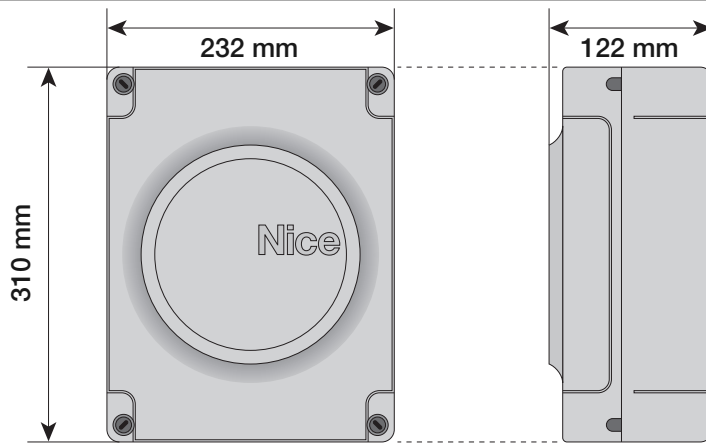

4

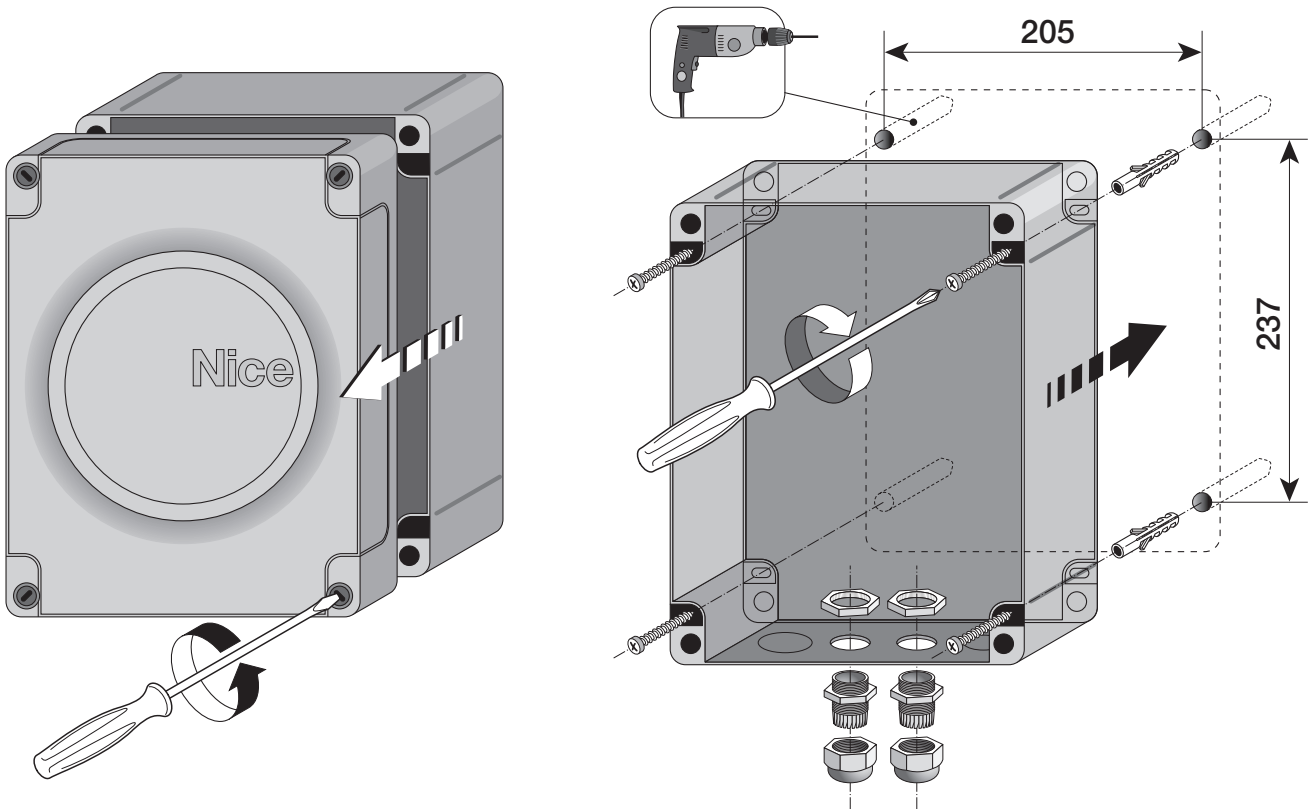

5a

- EN- Connection with "Stand by" active (energy saving)
- IT - Collegamento con "Stand by" attivo (risparmio energetico)
- FR- Connexion avec « stand-by » actif (économie d'énergie)
- ES- Conexión con "Stand by" activo (ahorro energético)
- DE- Anschluss mit aktivem "Standby" (Energieeinsparung)"
- PL - Połączenie z aktywną funkcją "Stand by" (oszczędność energii)
- NL - Aansluiting met "Stand by" actief (energiebesparing)

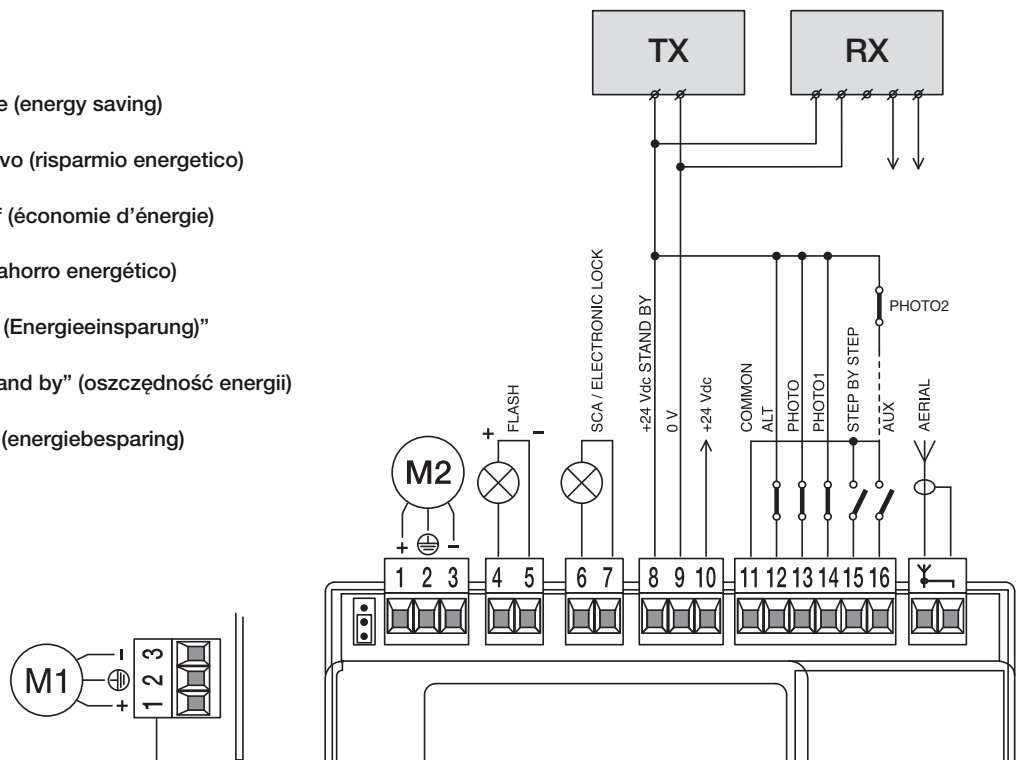

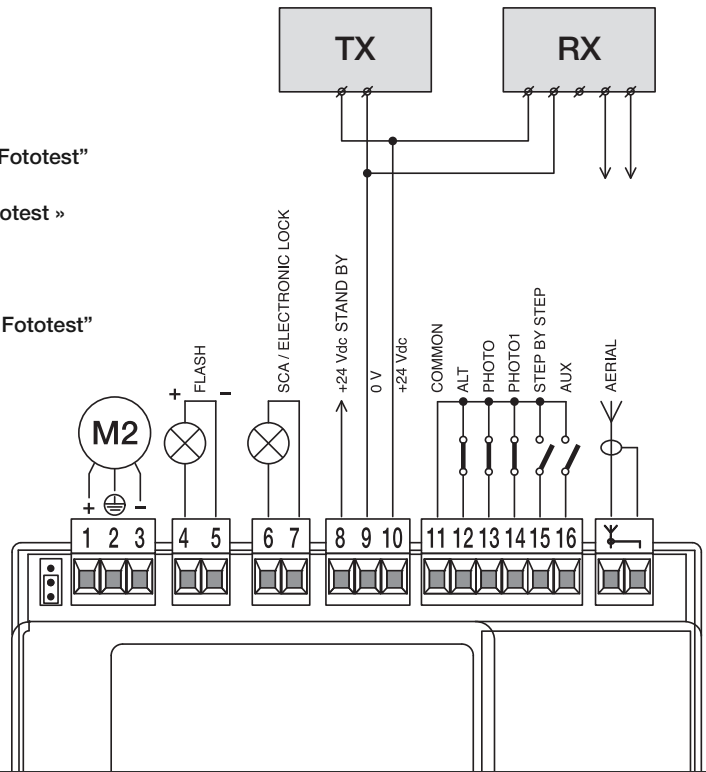
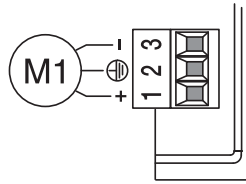
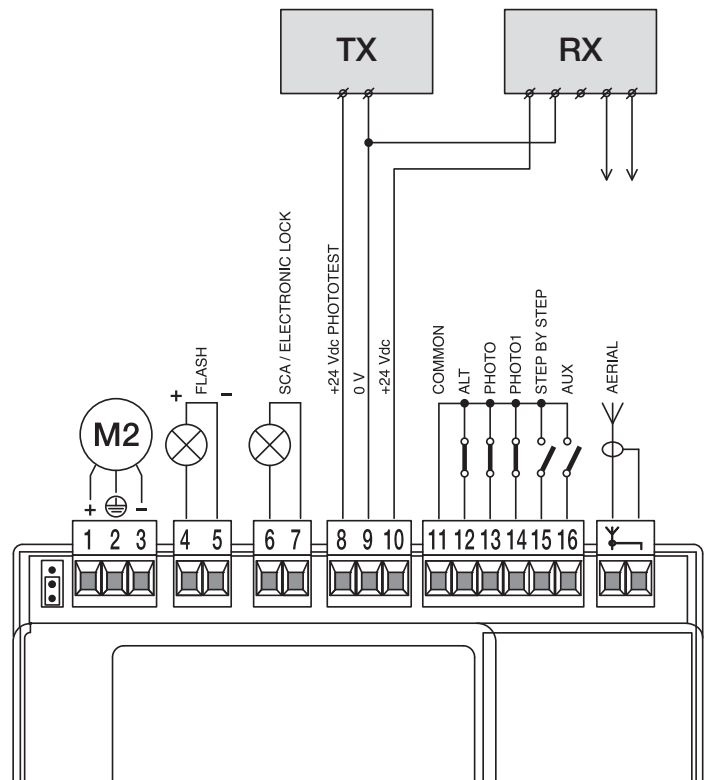
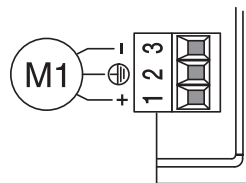
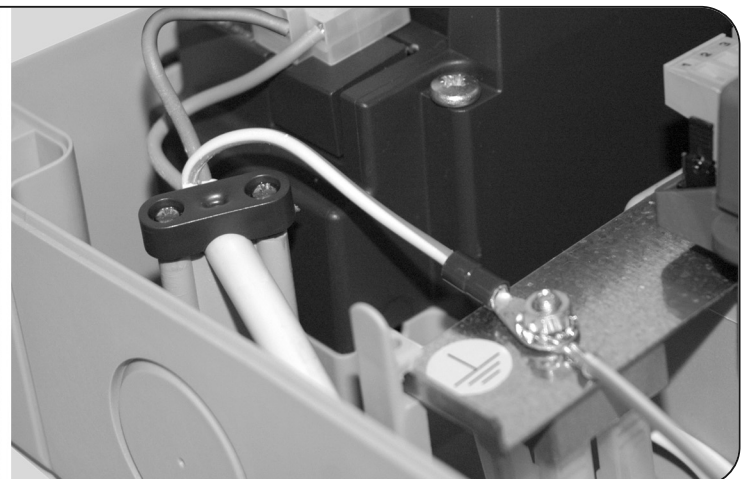
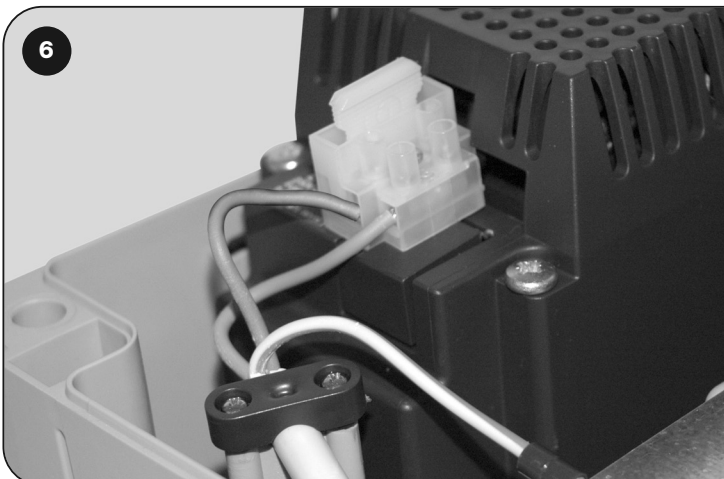
5b**EN** - Standard connection: without using Standby or Phototest**IT** - Collegamento standard: senza utilizzare "Stand by" e senza "Fototest"**FR** - Connexion standard : sans utiliser « Stand by » et sans « Phototest »**ES** - Conexión estándar: sin utilizar "Stand by" y sin "Fototest"**DE** - Standardanschluss: ohne Nutzung des "Stand by" und ohne "Fototest"**PL** - Połączenie standard: bez wykorzystywania funkcji "Stand by" i bez "Fototestu"**NL** - Standaard aansluiting: zonder gebruik van "Stand by" en zonder "Fototest"**5c****EN** - Connection without "Stand by" with "Phototest"**IT** - Collegamento senza "Stand by" con "Fototest"**FR** - Connexion sans « stand-by » et avec « phototest »**ES** - Conexión sin "Stand by" con "Fototest"**DE** - Ohne "Standby" und ohne "Phototest"**PL** - Połączenie bez funkcji "Stand by" i z funkcją "Fototest"**NL** - Aansluiting zonder "Stand by" met "Fototest"**6**

7a

STEP BY STEP

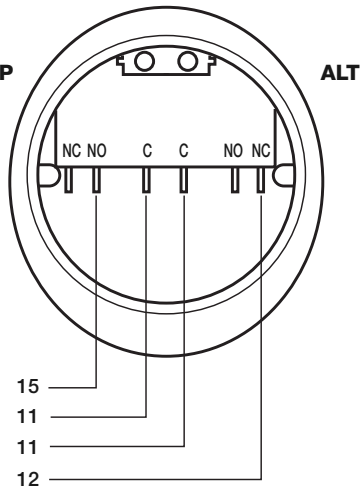

EN- For the ALT connection with "Stand by" active, connect terminal no. 8 and not no. 11

IT - Per il collegamento ALT, con "stand by" attiva, collegare il morsetto n° 8 e non il n° 11

FR- Pour la connexion HALTE, avec « stand-by » actif, connecter la borne n° 8 et pas la n° 11

ES- Para la conexión ALT, con "stand by" activo, conecte el borne n° 8 y no el n° 11

DE- Für den Anschluss STOPP, bei aktivem Standby, die Klemme Nr. 8 und nicht 11 anschließen

PL - Aby wykonać połączenie STOP z aktywną funkcją "stand by" należy połączyć zacisk nr 8 a nie nr 11

NL - Voor de aansluiting ALT, met actieve "stand by", sluit u de klem 8 aan en niet de klem 11

7b

STEP BY STEP

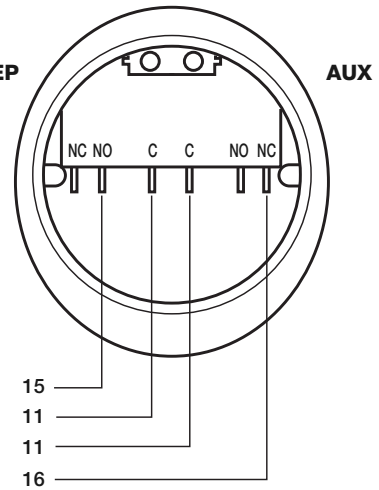

8

33 V \sim
max 5 W

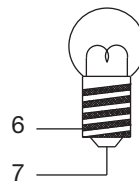

12 V \sim
max 25 VA

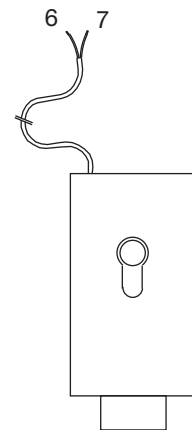

9a

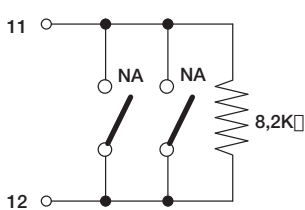

EN- With Stand by active connect terminal no. 8 and not no. 11

IT - Con Stand by attiva collegare il morsetto n° 8 e non il n° 11

FR- Avec Stand-by actif connecter la borne n° 8 et pas la n° 11

ES- Con "Stand by" activo, conecte el borne n° 8 y no el n° 11

9b

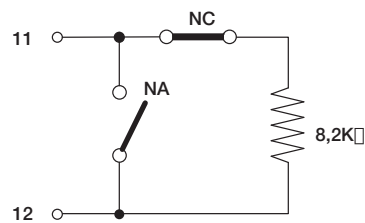

DE- Bei aktivem Standby, die Klemme Nr. 8 und und nicht 11 anschließen

PL - Z aktywną funkcją Stand by należy połączyć zacisk nr 8 a nie nr 11

NL - Met actieve Stand by sluit u klem 8 aan en niet klem 11

9c

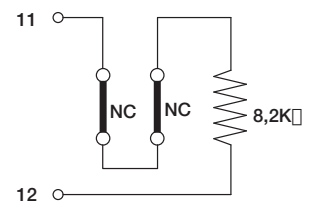

9d

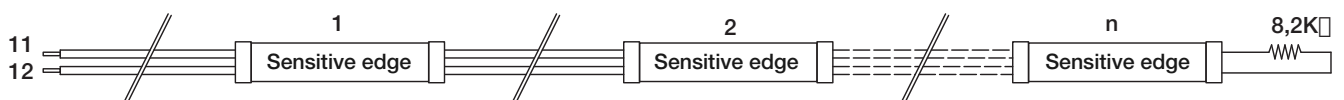

IT - Bordo sensibile

FR - Bord sensible

ES - Banda sensible

DE - Schaltleiste

PL - Listwa optyczna

NL - Contactlijst

IT - Bordo sensibile

FR - Bord sensible

ES - Banda sensible

DE - Schaltleiste

PL - Listwa optyczna

NL - Contactlijst

IT - Bordo sensibile

FR - Bord sensible

ES - Banda sensible

DE - Schaltleiste

PL - Listwa optyczna

NL - Contactlijst

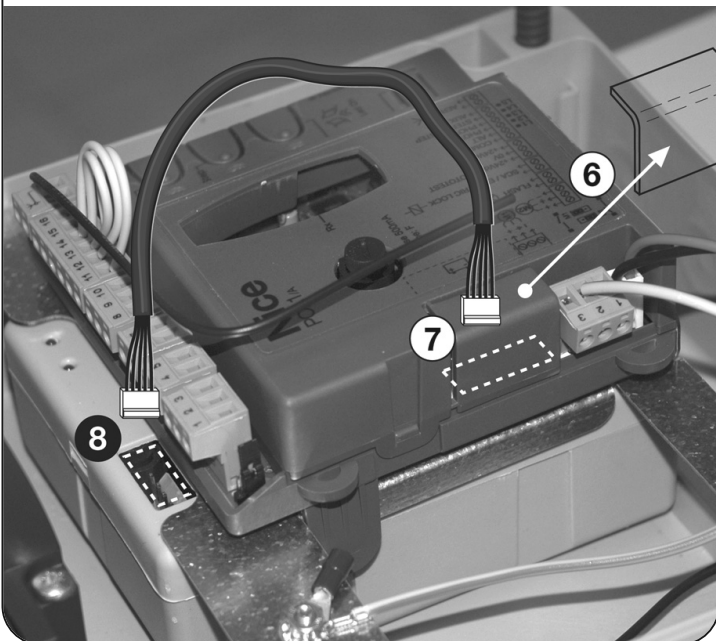
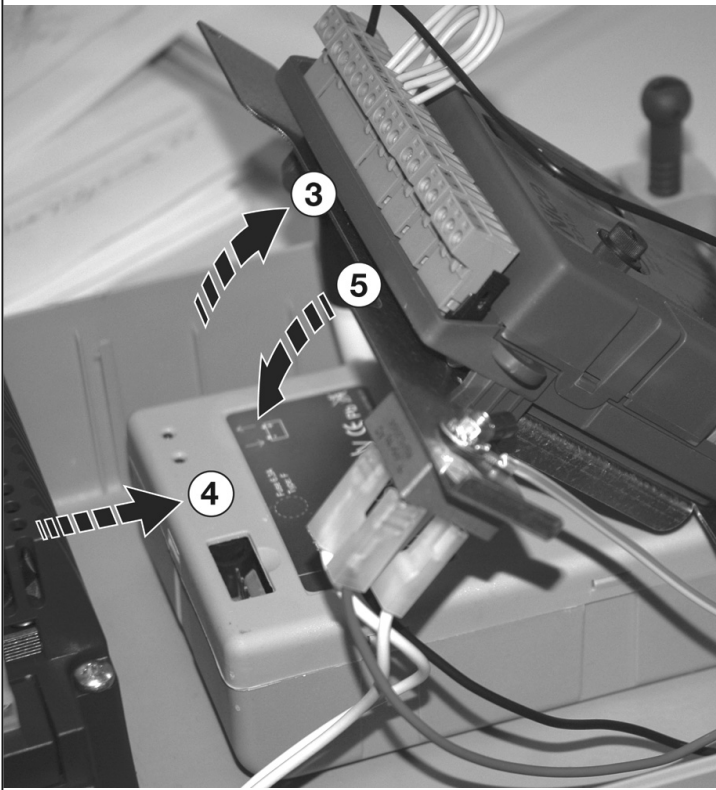
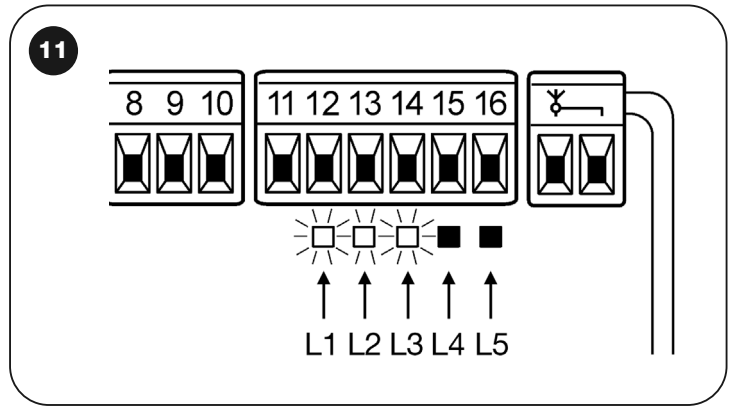
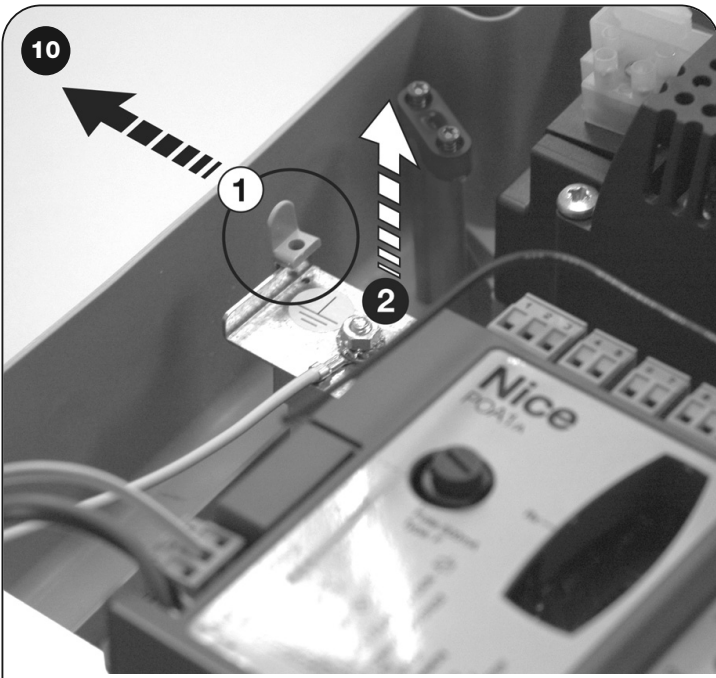



Nice

Headquarters

Nice SpA

Oderzo TV Italia
Ph. +39.0422.85.38.38
Fax +39.0422.85.35.85
info@niceforyou.com

Nice in Italy

Nice Padova

Sarmeola di Rubano PD Italia
Ph. +39.049.89.78.93.2
Fax +39.049.89.73.85.2
infopd@niceforyou.com

Nice Roma

Roma RM Italia
Ph. +39.06.72.67.17.61
Fax +39.06.72.67.55.20
inforoma@niceforyou.com

Nice Worldwide

Nice France

Buchelay France
Ph. +33.(0)1.30.33.95.95
Fax +33.(0)1.30.33.95.96
info@fr.niceforyou.com

Nice France Sud

Aubagne France
Ph. +33.(0)4.42.62.42.52
Fax. +33.(0)4.42.62.42.50
infomarseille@fr.niceforyou.com

Nice France Rhône Alpes

Decines Charpieu France
Ph. +33.(0)4.78.26.56.53
Fax +33.(0)4.78.26.57.53
infoyon@fr.niceforyou.com

Nice Belgium

Leuven (Heverlee) Belgium
Ph. +32.(0)16.38.69.00
Fax +32.(0)16.38.69.01
info@be.niceforyou.com

Nice Deutschland

Gelnhausen Deutschland
Ph. +49.(0)6051.91.520
Fax +49.(0)6051.91.52.119
info@de.niceforyou.com

Nice España Madrid

Mostoles Madrid España
Ph. +34.(0)9.16.16.33.00
Fax +34.(0)9.16.16.30.10
info@es.niceforyou.com

Nice España Barcelona

Sant Quirze del Valles
Barcelona España
Ph. +34.(0)9.37.84.77.75
Fax +34.(0)9.37.84.77.72
info@es.niceforyou.com

Nice Polska

Pruszków Polska
Ph. +48.(022).759.40.00
Fax +48.(022).759.40.22
info@pl.niceforyou.com

Nice Portugal

Mem Martins Portugal
Ph. +351.21.922.82.10
Fax +351.21.922.82.19
info@pt.niceforyou.com

Nice Romania

Cluj Napoca Romania
Ph./Fax +40.(0)264.453.127
info@ro.niceforyou.com

Nice Turkey

Kadikoy Istanbul Turkey
Ph. +90.216.456.34.97
Fax +90.216.455.78.29
info@tr.niceforyou.com

Nice UK

Sutton in Ashfield
United Kingdom
Ph. +44.16.23.55.80.86
Fax +44.16.23.55.05.49
info@uk.niceforyou.com

Nice Australia

Wetherill Park Australia
Ph. +61.(0)2.96.04.25.70
Fax +61.(0)2.96.04.25.73
info@au.niceforyou.com

Nice China

Shanghai P. R. China
Ph. +86.21.575.701.46/45
Fax +86.21.575.701.44
info@cn.niceforyou.com

Nice USA

Jacksonville Florida USA
Ph. +1.904.786.7133
Fax +1.904.786.7640
info@us.niceforyou.com